

ISSUE

6

JULY  
2007

# Star FRONTIERSMAN



## FADE TO WHITE

CIRCLE OF FATE: CHAPTER 1  
SENTIENT ROBOT CHARACTERS  
THE EAST INDIAMAN REVISITED  
DETAILS OF THE PRENGLAR AND GRUNA-GARU SYSTEMS  
SATHAR WAR I – GREAT WAR STRATEGIES  
THE AVIAN ARBOREANS  
ADDING THE THIRD DIMENSION TO KNIGHT HAWKS MOTION  
A NEW ZEB'S GUIDE MAP  
VIRTUAL TABLETOP GAMING  
MORE GEAR, MAP TILES, ADVENTURE, AND MORE!



# Star FRONTIERSMAN

Issue 6: July 2007

<b>SENTIENT ROBOTS</b>	
Self-aware PC/NPC robots, by Bill Logan.....	1
<b>STARSHIP</b>	
The East Indiaman Medium Freighter, by Stuart Shaw ..	6
Knight Hawks scenario by Bill Logan.....	12
<b>THE PRENGLAR SYSTEM</b>	
Details of the hub of the Frontier, by Allen Trussel .....	13
<b>SATHAR WAR I</b>	
Great War Strategies, by Mark Singleton .....	17
<b>PLANET OF MYSTERY</b>	
The Arborean race, by R. Kevin Smoot.....	19
<b>ABILITY SCORE LIMITS</b>	
Modifiers and maximums, by R. Kevin Smoot.....	22
<b>SHADES OF MOTION</b>	
3D movement in Knight Hawks, by C.J.Williams .....	23
<b>NEW EQUIPMENT</b>	
A few new pieces of gear, by Bill Logan.....	26
<b>THE GRUNA-GARU SYSTEM</b>	
The most militant Yazirian system, by Scott Nelson....	28
<b>MAP TILES</b>	
More tiles for use in city and jungle, by Bill Logan.....	33
<b>CIRCLE OF FATE</b>	
First chapter of a great story, by Auden Reiter .....	35
<b>SECTOR 6</b>	
A sketch of a campaign setting by Bill Logan .....	38
Saran Wolfe NPC character sheet, by Bill Logan.....	41
<b>FRONTIER FACELIFT</b>	
New Zeb's Guide Map, by Darrell C. L. Donald.....	42
Virtual Tabletop gaming, by Darrell C. L. Donald.....	43
<b>BUYING AND SELLING IN THE FRONTIER</b>	
Adventures in economics, by C. J. Williams .....	44
<b>BONUS EQUIPMENT ILLUSTRATIONS</b>	
Redrawn images from Issue #1, by Bill Logan.....	47
<b>CLASSIFIEDS</b>	
No more plugs! Satirical Classifieds by Bill Logan.....	48

## ON THE COVER

The scoundrel Rivven Krendal was caught with the daughter of the ambassador. He would have gotten away with a charming smile and a "I'm sorry, sir" but the ambassador's wife gasped a loud "Rivven?!" - letting slip that she knew the rogue all too well herself. Rivven escaped by stealing one of the family's fleet air cars, but finds himself being pursued by security agents whose actions are protected by diplomatic immunity!

This art was used with permission by Darren Allanson. Check out his gallery at Epilogue.net. He's quite talented.

## FOREWORD

All I can say is wow. I usually run into an odd crunch time at the end of the month, a point in which I beg regular submitters for material, post in forums reminding people to get their submissions to me, and turn gaming experience into webzine content in order to make the issue filled with stuff.

This time, I had so much stuff I didn't know what to do with it all! Most of it made it into this issue. I decided to reorganize a little - abandoning my previous system of categorical articles. What you now hold in your hands (or are reading on your computer) is the result of a month full of submissions.

Each issue the size of the webzine grows. That's great - but it's not something I aim for. I worry slightly that one month the number of submissions will wane and I'll end up putting out an issue smaller in size (though hopefully not quality) than the month before it. It's bound to happen... and I honestly thought (after last issue's whopping 40 pages) that this would be the dreaded downsized issue. But here it is, from cover to cover nearly fifty pages, and I didn't get there by making the font really big :-)

But let's not rest on our laurels. We're making something great, and it's not great because of any one person's efforts. It's great because of ALL of our efforts. We are gamers, nerds, dorks, whatever. So be it. We're also very talented at what we do. We're artists of a different type, a different age. Let's keep working together to make each issue amazing.

If you're one of the many people downloading these issues, and haven't submitted anything, what's keeping you? Even if all you do is write up a single piece of gear, share a single starship or critter. Even if you don't play Star Frontiers, but would have an idea for a nice plotline for an Adventure! article, even if you can't draw... what's keeping you from adding your talent to the pool of greatness that's evolving? This is a free publication, by fans, for fans... if you're a fan... step up and add your talent? I for one am excited to see what you have to offer.

Bill Logan  
Referee@StarFrontiersman.com  
Last Revision: 07.04.2007

STAR FRONTIERS, WIZARDS OF THE COAST, and the WIZARDS OF THE COAST logo are trademarks belonging to Wizards of the Coast, Inc., a subsidiary of Hasbro, Inc., and are used here without permission. © 2001 Wizards of the Coast. All Rights Reserved. The free distribution of this revised edition of the out-of-print game system is not intended to detract income from Wizards of the Coast.

# SENTIENT ROBOTS

Bill Logan

## ROBOTIC PC/NPC'S

The Frontier is a big place, with many races and many types of technology. Jumps to voidspace, anti-gravity, and inertial control on such a level that it is beyond our understanding. Robots are very high-tech, and can be dangerous to face. But until now, robots couldn't be intelligent enough to be a player character.

Zebulon's Guide to the Frontier added the Mechanon race, which allowed players to play a sentient robot. These rules weren't well-received and produced characters which were disproportional in power. Lovers of other forms of sci-fi have long imagined (or created house-rules for) robotic characters.

## IMPROVED AI

Sentient Robot PCs and NPCs have a new "special program" that other robots lack (just like there are attack/defense programs and such) called Improved Artificial Intelligence (or Improved AI). This program includes complex circuitry and hardware in addition to the huge amount of programming required by such a large piece of firmware. It is not a program found commonly in the Frontier. It's a rare and powerful program that includes a great deal of added technology that is cutting edge, created in unique labs here and there throughout the Frontier. The creators of this program are a secretive lot, and may not give up their beloved technology lightly (they may require huge favors in exchange for their technology).

Installing an Improved AI program means losing other technology because of incompatibility and space/power requirements. Only level 6 robots can have an Improved AI program, and it is very expensive (15,000 Credits for the program's software and hardware and installation).

The Improved AI hardware and software gives the robot the ability to adapt, grow, make decisions, have a sense of self, receipt and use of tactile sensors to have a sense of touch, approximation of sense of smell through special air receptors and membranes, and other things that define *sentience*. The robot will be able to ponder situations even when not directly confronted with them, has random thoughts moderated by need and current focus level, can express its thoughts imaginatively, and will wonder about its place in the universe. It will basically become a PC, with the following modifications:

- **Ability Scores.** Installation of the Improved AI hardware and software can have unpredictable results on the performance of the robot. Each installation on a robot model will require rolling all ability scores as per normal. That is, if you take a robot and install Improved AI, you then go through the process of creating a character's statistics (except you don't select

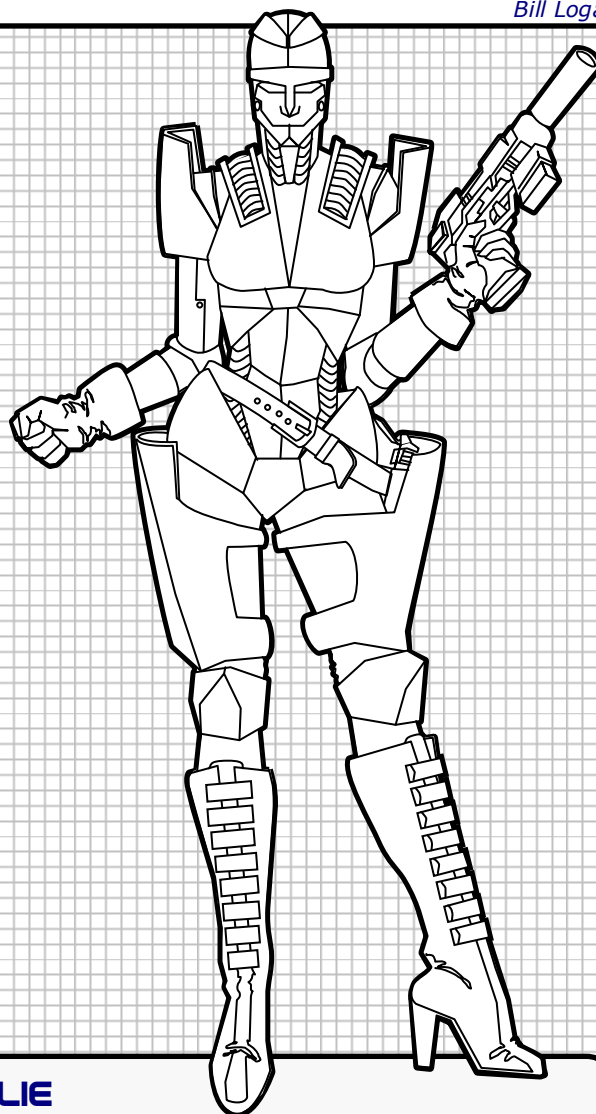

### ELLIE

Ellie (short for "11E") used to be a trackerbot, a synthetic bounty hunter. It had an anthropomorphic body type and was equipped with the Search & Destroy and Security Lock programs. Its owner enjoyed the company of Ellie and the services it rendered and when he came into a large sum of money, paid for the Improved AI upgrade. Ellie resented "her" servitude and left the owner, but can't shake its desire to hunt down criminals. But now "she" brings these criminals to justice instead of an employer.

<b>STR/STA</b>	55/55	<b>IM</b>	+5
<b>DEX/RS</b>	50/50	<b>PS</b>	1d10+3
<b>INT/LOG</b>	45/45	<b>RW</b>	25
<b>PER/LDR</b>	20/40	<b>MW</b>	28

**Skills:** Military PSA, Projectile Weapons 1, Environmentalist 1

**Equipment:** Type 2 Parabattery (1,000SEU), Autopistol (20 bullets), Integrated: Chronocom, Compass.

race!). The ability score modifiers are as follows (Heavy Duty robots (NPC only) have an additional 300 Stamina)

STR/STA	+10
DEX/RS	+5
INT/LOG	+5
PER/LDR	-20

The increase to STR/STA should be fairly obvious, as standard Alpha Dawn game system robots are always found with Stamina scores of 100. Even though a PC robot has some of his superstructure hardware displaced by the Improved AI installation, it is still a durable piece of technology.

DEX/RS were given only a small adjustment because a level 6 robot normally is shown with a 90% RS score. Just as other features were cut in half by technology downsizing and displacement by the Improved AI equipment, so too were the reflexive motors and subsystems, making a robot PC typically start with an DEX/RS only slightly better compared to other races.

INT/LOG was tricky. Robots are very logical, though Logic and Intuition take more into account than mere logic. Since an Improved AI program is like giving a baby-level of sentience to a robot, starting robot PCs begin with only slightly better than average INT/LOG, and must improve them with experience points.

PER/LDR is lower due to the inability of robots to give proper body language and facial expressions, and the general lack of acceptance of robots as sentient beings in the Frontier.

**Optional Rule:** Cybernetic robots ("cybots," as described on page 65 of the Alpha Dawn remastered book) that have anthropomorphic body types look very much like a biological being. They even have extra very fine motors and sensors, allowing them to simulate facial expressions. If playing a cybot, a character will cut his "PER/LDR" starting ability score penalty in half, -10 instead of -20.

**Skills.** Other programs the robot has prior to installation of the AI help to decide which player-character skills it will have. Once Improved AI is installed, no other programs may be installed (because the robot will learn like a normal character by using experience points).

Robot Program	Skill Integration
Restrain	Martial Arts
Self Defense	Melee Weapons
Attack/Defense	Weapon skill of choice
Search & Destroy	Environmentalist or Demolitions
Computer Link	Computers
Security Lock	Technician or Robotics

For simplicity sake, if creating a starting-level robot PC, you may select any two of these skills for free (their selection of skill is limited to the above list, basically any Military or Technological skill, no BioSocial skill except Environmentalist), just like a normal starting PC can, each at level 1. You must then select either Military or

Technological PSA. Please note that you need not list the "program" - it becomes obsolete and is rolled into the skill memory bank of the AI ware.

**Other Programs.** Note that after conversion to sentience through installation of this rare and unusual Improved AI program, robots never again purchase programs. The new mental faculties they possess will reject the new technology, making it useless to them. They now learn like any other character. See Improvement, below.

**Movement.** Movement modes go unchanged, though speed is reduced because of the displacement and downsizing of components to make room for the AI ware. If creating a starting-level PC, you may select a form of movement: limb, wheel, hover, rotor, or rocket. Each has an obvious limitation and advantage. Movement rates for each type are as follows:

Movement Mode	Walk	Run	Hourly
2 Legs	10m/turn	30m/turn	5kph
More than 2 Legs	15m/turn	35m/turn	6kph
Wheeled*	40m/turn	80m/turn	25kph
Tracked**	50m/turn	75m/turn	25kph
Hover***	35m/turn	125m/turn	30kph
Rotor****	25kph	150kph	25kph
Rocket*****	200kph	500kph	200kph

\* Wheeled robots maneuver like a ground car.  
 \*\* Tracked robots maneuver like an explorer.  
 \*\*\* Hover robots maneuver like a hover car.  
 \*\*\*\* Rotor robots maneuver like a jetcopter.  
 \*\*\*\*\* Rocket robots maneuver like an air car.

Multiple types of movement are possible (just like for normal robots). A starting-level Robot PC can select only one of these modes, however, but may consider adding gear at a later time through expenditure of earned experience and credits (see Improvement, below).

Note that depending on the creativity of the player and the design of the robot that has been converted, the movement rate and carrying capacity may or may not be identical to the rules governing regular characters. This must be determined by the Referee on a case-by-case basis, and should always be balanced by some form of limitation.

**Wheeled** robot movement is provided as an option here, but is not in the core Alpha Dawn rules book. Cost of such a mode of movement is the same as a standard pair of limbs: 800 Credits. Wheeled robots have certain inherent limitations: they have difficulty with some terrain, and can't navigate stairs well.

**Tracked** movement is like that of an explorer or excavator - designed to handle very rough terrain (and in some cases climb very uneven surfaces - depending on the size and angles of their tracks). Tracked movement can be purchased for 1200 Credits.

Players can use these modes of movement for other robots in their games if desired.

- **Mass.** All robots weigh 100kg if they have a standard or anthropomorphic body type, or 500kg if they have a heavy duty body (NPC only). This does not include the parabattery or installed or carried gear.
- **Combat.** All combat stats (MW, RW, IM, etc.) are all determined like a normal PC.
- **Punching Damage.** Punching damage is reduced by half due to the fact the robot now has simulated nerve endings and reduced damage capacity (and because certain servo motors were downsized to allow for the massive amount of Improved AI software and hardware). Thus, a standard or anthropomorphic body type causes 1d10 damage with a punch (plus PS), while a heavy duty robot (NPC only) causes 3d10 damage.
- **Handedness.** Regardless of the number of limbs, a robot PC/NPC must select a "Primary" hand. The AI software is excellent, but can't coordinate any better than other PC races. If the robot body type has more than 2 arms, it can't effectively use more than one 2-handed weapon or two 1-handed weapons at one time.
- **Installed Equipment.** Any integrated equipment at the time of Improved AI installation is still in use, as normal. Thus, if a robot has Magnigoggles and a Radiophone before the AI conversion, he'll still have those pieces of technology integrated into his body. Generally, most PC/NPC robots have a sense of self (determined at the point of Improved AI installation), and would loathe installation of new gear that would make them not feel like themselves anymore (just like a human wouldn't generally want to cut off his own hand and install a new one with a cigarette lighter in the thumb... um whatever) see Improvement, below.
- **Mission & Functions.** A robot is normally given a Mission "Protect the Base" and a series of Functions that define the words and methods of that mission. Functions are dropped when the Improved AI circuitry is installed. However, a robot's mission is so key to its being that residuals of that mission remain in the robot's memory and end up bleeding into the AI circuitry. The mission becomes a preference, or a morality, or a personal code, all interpreted by the player. A mission of "assist anyone looking for directions" might turn into a robot who gets enjoyment and is genuinely pleased with itself whenever it helps others find their way. This could later be interpreted by the player as a calling to do social work. Mission is just a role-playing tool in the use of Robot PCs.

## IMPROVEMENT

- **Ability Scores.** Robot PC/NPC characters earn experience just like everyone else. They may improve their ability scores, but doing so requires a financial cost as well. Normally, it costs 100 Credits per experience point spent to improve an ability score. This represents self modification and assisted modifications in a robotics lab. For example, if a robot PC wanted to increase its RS score from 40 to 45, it would cost 5 experience points and 500 Credits. Robot PCs can NEVER spend experience points on ability score improvement during an adventure. It must always be between adventures or missions while in a city that includes a publicly usable robotics lab or the PC's own lab. It requires time and materials and tools that aren't portable, though the Robot can basically install these modifications itself (except Logic improvements, which must be done by someone else because the robot's AI brain must be switched off for a period of time).

### SQUATTO

Squatto took on his own name after Improved AI installation. He read the name in a StarLaw blotter, and took a liking to it. Squatto was a StarLaw police robotic mount. StarLaw officers would ride on his back and provide nice conversation and companionship to him, as well as militant backup when needed. His standard body type has a centaur-like shape (the Referee permits him to carry up to a 100kg rider without affecting his movement rate). Before conversion, he had the Restrain and Security Lock programs, along with an integrated electrostunner as a right hand.

Squatto still works for StarLaw, but isn't an officer. He is considered property, but he doesn't mind that. He forms a strong bond with his rider, and only allows someone he trusts to mount up. Since he isn't paid for his work, he is actually free to come and go as he pleases. For now, he'll continue his StarLaw life.

<b>STR/STA</b>	45/65	<b>IM</b>	+6
<b>DEX/RS</b>	60/60	<b>PS</b>	1d10+3
<b>INT/LOG</b>	45/45	<b>RW</b>	30
<b>PER/LDR</b>	30/30	<b>MW</b>	30

**Skills:** Military PSA, Beam Weapons 1, Martial Arts 1.

**Equipment:** Type 1 Parabattery (500SEU), Integrated: Electrostunner, Chronocom, Compass.

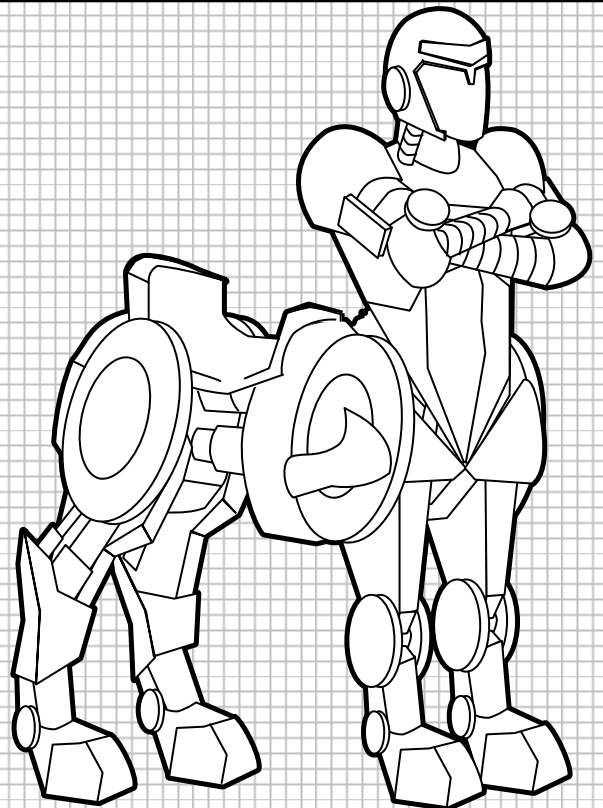

- **Skills.** Skills can be improved as per normal. This includes purchasing skills from the Medical and Psycho-social skill (normally barred from starting-level robots, see "skills" above). Purchase of skills requires no financial cost unless purchasing the sixth level of skill in any given skill. This is a limitation on the AI software... as it requires a skill memory upgrade to allow room for such advanced knowledge. This is a simple 5,000Cr purchase that must be paid at the same time the experience points are spent on the skill purchase.

- **Installing Hardware.** When having equipment installed (such as new limbs, modes of movement, defenses, weapons or miscellaneous items designated with a "r" in the equipment tables), the robot will have the same normal aversion to self mutilation as would any other PC. If they choose to change their bodies in this way, and the normal 10% fee is paid in addition to the equipment in general, the robot will also have to spend experience points on the improvement (since it requires acquired skills and talents to use the new equipment). The cost is equal to 1 experience point per 1,000Cr worth of gear installed (minimum 1). Thus, if a robot wanted to have installed Magnigoggles, it would cost 200Cr for the gear, 20Cr for the installation fee, and 1 experience point to use it. If it later wanted to add an integrated rocket pack mode of movement, it would cost 10,000Cr for the altered movement mode (according to the Robotics table in the equipment section of the AD book), 1,000Cr for the installation fee, and 10 experience points to use it.

## MAINTENANCE

- **General Health.** A robot requires regularized maintenance to keep it functional. Referees are encouraged to treat the robot as feeling ill when maintenance is not performed (the robot goes more than a month without time spent in an equipped robotics lab), receiving a penalty of -10 to all actions. Maintenance is performed by the robot himself, just like normal characters know how to feed themselves and drink liquids. Note that a robot doesn't breathe, but may sniff to facilitate a sense of smell. Robots cannot get diseased and can never be poisoned (unless you call that special brand of vile programming commonly referred to as a "virus" as a toxin, in which case you could use normal poison/toxin rules!)

- **Sleep.** A robot with Improved AI must shut down occasionally to run diagnostics. Treat this just as sleep for a normal character. If the software goes too long without running a diagnostic routine, the robot AI acts up - generally making it irritable and can even result in other symptoms identical to sleep deprivation. While running diagnostics, the robot is reduced to a lower power mode and appears like it is actually sleeping, though it can be awakened in the normal way any character can (which interrupts its diagnostics).

- **Sustenance.** A robot doesn't process food or liquid, but does require power. A standard body is powered by a type 1 parabattery (500 SEU) and a heavy duty (NPC only) or anthropomorphic body is powered by a type 2 parabattery (1000 SEU), as per normal AD rules. The battery will provide enough energy to power the robot's

systems through normal expected use for around 6 months. That works out to be a drain of about 1 SEU per day from a type 1 parabattery or 2 SEU per day from a type 2 parabattery. This is the food of the robot. This is to supply movement, operate sensors, power the brain, etc. Firing weapons or powering defenses will cost additional SEU and significantly reduce the parabattery lifespan, though external power sources may be used for such weapons and defenses (even if installed). If depleted of parabattery, the Improved AI goes into a hibernation mode to preserve its identity in a non-volatile memory area. If re-powered by a friend, it will be fine.

- **Healing.** Most player's character heal naturally or through medical repair. Robots are different, though similar. Given enough time, a robot will work the kinks and damage out of itself, and be able to tweak and repair its own damage. This simulates normal healing but assumes the robot has the ability (tools, time, spare parts, etc.) to work on its damage. Anyone with Robotics skill can repair the robot with a successful Repair Robot skill check, providing they have the time, tools, and materials. To make the playing of robots balanced against the playing of characters, there are three distinct types of robotic healing:

- o **Natural Healing.** This is like normal healing from any other race (that is, 1 STA per 20-hour day spent recuperating).
- o **Patch Job.** This is like the "First Aid" medical skill. Without a lab, time, or proper materials, this is the only kind of repair a robotics expert can perform on a robot PC. It heals 10 points of lost STA with a successful Repair Robot skill check.
- o **Minor Repair.** This is a repair that is lacking one but not more of the following: the time necessary, the tools necessary, or the materials necessary. It heals 20 points of damage with a successful Repair Robot skill roll. Performing a Minor Repair takes approximately 20 minutes.
- o **Major Repair.** This type of repair work is what a robotics expert can perform when he has the time, tools, and material to do so. A successful Repair Robot skill roll will heal all damage, but for each 10 STA repaired (or fraction thereof), 100Cr worth of material is used and 1 hour of time is spent.

## SOCIAL & LEGAL CONSIDERATIONS

**Ownership.** It's also important to note that a robot begins life as owned property, and depending on the circumstances behind the robotic upgrade to Improved AI, the previous owner may still consider the robot property. How the robot reacts to this knowledge is left up to the role-playing preferences of the controlling player.

The Frontier views robots as helpful or harmful pieces of owned equipment. Most people will have difficulty associating with your robot PC or considering it a "friend." How a robot PC reacts to this fact is up to the controlling player. In some places, the robot won't be allowed in a building and must wait in a lobby with other robots, most of which won't be sentient at all.

## ROLE-PLAYING A ROBOT

The purpose of this article isn't to create armies of player character robots. It's so that an unusual player or two can accept a complex challenge of a very unique role-playing experience. Because the pay-off doesn't normally compensate for the cost, and because the law generally doesn't support the existence of a sentient robot, installing Improved Artificial Intelligence should be a rare and wondrous thing.

Robots will have self-awareness thrust upon them, and they may or may not like it. Maybe it was easier being a slave to the program they were bound by. Maybe it was easier not having to weigh everything on a moral balance. Maybe being sentient isn't easy... and the robot will regret it. Although it's easy to assume any robot would be thankful, that's not necessarily the case.

The robot will most likely spend a lot of its time pondering things. It will wonder on its place in the Frontier, on whether or not it's really sentient or the result of very clever programming. It might wonder about religion. After all, many people around it will claim that wonderful things await them after death... because they will go to join their creator. Since the sentient robot is sitting there talking to representatives of its creator, then what will happen when the robot dies? Does it go to a wonderful place too? Or does some kind of big empty oblivion await it?

Some robots may rebel against its former "masters" while some may embrace them as dear friends. Some may run amok and be quite deranged. After all, natural selection seems to help ensure that normal living beings are more or less healthy, and modern medicine and scientific discoveries picks up the slack where natural selection's occasional randomness fails to keep a species perfect. Robots don't have millions of years of natural selection to help keep their 'species' on the right track.

Some robots will find themselves wanting companionship of a type that living beings can't appreciate. Coupling with another robot, however, will prove less than satisfactory, while locating another sentient robot will prove complex. One thing robbed from them (when compared to all other races) is the ability to procreate. This is both unfair and sad - and may often lead to feelings of self worthlessness.

Note that there is no reason a robot will be a good guy. His interpretation of morality need not be in line with those around him. Many things can explain this: crossed wires, bad programming, poorly worded mission statements, or simply a sentient mind choosing evil. Referees may not permit sentient robot PCs, but you may run into one in-game as a clever and potent foe.

Whether or not you role-play your sentient robot as an upbeat being craving social interaction or a moody, self-reflective morose sulking brute pondering his worth more than his peers, is up to you. Whether you're playing the robot as your primary character or as an NPC that accompanies your character, it will certainly prove to enhance the content of your campaign's story depth.

**The Law.** The law doesn't recognize a robot as sentient, no matter how well programmed. Most psychologists agree with this, though some arguments have been made in political circles. What defines sentience? Surely, having a sense of self, showing the effects of both mental and physical distress and pain, showing creativity, learning, adapting, and communicating are all indicators. The only thing remaining is the religious implication. But the law has yet to adapt to consider a robot of any technology level as sentient and may never succeed in doing so. For this reason, a robot PC who commits murder or other crimes may be ordered to have its Improved AI ware wiped clean and force the robot to begin anew with no previous memories, or even ordering it destroyed as flawed technology that is unsafe for the people of the Frontier. On the plus side, it will never have a criminal record nor will it spend a single day in any containment facilities.

## CHARACTER CREATION SUMMARY

Below are the summarized steps to creating a starting-level Robot PC (same steps as the AD book):

1. Use a normal character sheet.
2. Determine Ability Scores (using the modifiers below)
  - STR/STA +10 \*
  - DEX/RS +5
  - INT/LOG +5
  - PER/LDR -20
  - \* (NPC Heavy Duty robots have +300 STA)
3. Race will be "Robot" or "Anthropomorphic Robot" as desired. NPC robots may be "heavy duty robot" instead. Racial abilities are:
  - Punching Damage 1d10 (NPC Heavy Duty robots 3d10)
  - Movement (pick any one: limbed, wheeled, hover, rotor, or rocket)
  - May install robotic gear at 10% fee, but must spend 1 XP for each 1,000Cr worth of gear.
  - Improvement of Ability Scores between missions is possible, but costs 250Cr per XP spent.
  - Doesn't breathe, eat or drink, but sleeps (runs AI diagnostics) normally and requires 1 SEU per day (2 if anthropomorphic) to exist.
  - Heals like all other characters, though technicians do the repair-work instead of medics.
4. Determine Combat Abilities (IM, PS, MW, RW) normally
5. Determine Skills: select either Military or Technological PSA, then select one skill in your PSA and one skill in either of those two PSAs. Environmental skill may also be chosen as the second skill, but not Psycho-social or Medic.
6. Equip your character by rolling d100+250Cr. Any purchased equipment may be installed if a 10% fee is paid, otherwise it's gear you're carrying around. Use any normal starting gear rules your Referee allows.
7. Details: name, appearance, handedness, etc. Remember a robot "Mission" becomes a moral compass that guides it, so noting your "Mission" may be required by the Referee or desired by you.



# STARSHIPS



## THE EAST INDIAMAN CLASS MEDIUM FREIGHTER

*Revamped by Stuart Shaw*

**Editor's Note:** This article first appeared in the September 1984 issue of IMAGINE magazine. Stuart Shaw enjoyed that article and thought it could use some new art and some revamping. He did an amazing job. This article is the first in a potential series of articles showing some starship designs, complete with deck plans and exterior images, for players in the Star Frontiers game.

Knight Hawks is a really big toolset for the creation of starships, but one thing lacking in that set of rules is a repository of standard ships commonly found throughout the Frontier. Every ship has to be created from scratch. This article serves to correct that oversight. Future articles can include submissions from anyone... even if you're not artistic enough to pull off the deck plans or images. We're a pool of creative talent and we all have our role.

Page references are to the original texts, not the Digitally Remastered versions of those same books.

The East Indiaman Class is based on a size 10 hull. It has a beam of 39m of an overall length (including the drives) of 210m. The ship's only defensive system - a reflective hull - is provided as standard, as is a laser battery mounted in a chin turret.

East Indiamen are usually powered by three type B ion engines - these are usually de-rated military drives, or occasionally UPF-surplus drives. Launched from the airdock of Tallyman Associates (the designers) at Triad starport, a basic East Indiaman as described below costs Cr 1,330,000. If built by a licensed contractor at another Class I starport the cost of the basic ship rises to Cr 1,570,000.

Atomic drives can be fitted in place of the ion engines. This version, including an up-rated Drive program and deluxe astrogation package costs Cr 2.4 million. The ship's ADF is 3 with atomic drives. All other statistics remain the same.

The deck plans, side view and descriptions which follow in the sections below are for a typical cargo carrying East Indiaman. As such, the ship serves as an excellent example of what is delivered to a customer by Tallyman Associates. Naturally, customers and crews rapidly alter and add to the basic specifications to make a ship more like home.

**Construction standards:** The hull is made of poly-carbon and is capable of sustaining 200+2d100 points of structural damage at any point (portholes are made of armored plastic, and can take the same damage). Airlock hatches can take 200+d100 points of structural damage internally, breaching the bulkheads requires 50+2d10 points of damage. Unless noted otherwise, compartment doors are of heavy construction (c.f. Structural Points table; Alpha Dawn Expanded Rule Book p25).

**Security Systems:** The hull is fitted with skin sensors that are tied into the Installation (Ship) Security program. A full size camera system giving coverage of the entire ship is also fitted. The resulting video images may be displayed by any computer terminal on the ship. The Ship Security program also controls movement through a system of cardlocks.

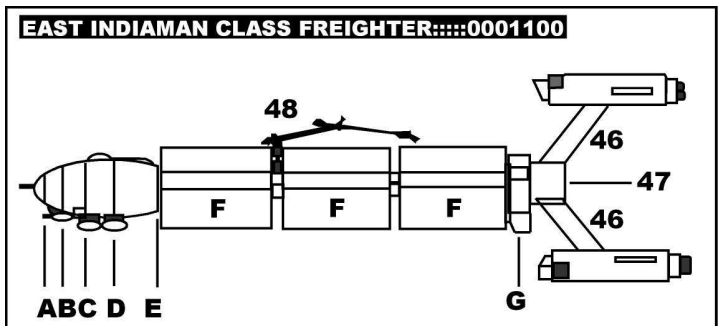



Crew ID cards will open all airlock hatches and doors on the vessel, and allow use of the elevator. Access to the cabins and the Bridge is usually restricted to nominated crew members. When issued, passenger ID cards allow access to the passenger's cabin, the mess and the recreation lounge. The elevator cardlock will only allow access to decks where the user's ID card can open doors.

Although not mentioned in any Tallyman sales literature, there is an additional security system fitted. Built into both of the Life Support systems are tranquillizer devices that can be triggered from the Pilot's position on either Bridge. Anyone who is not wearing some form of protection – a space suit, an emergency suit or a gas mask – is treated as being in the burst radius of a doze grenade when either of these systems is activated. Usually only the Ship's master, pilot and engineer are told of the existence of this system.

**Elevator:** The central lift shaft is built to the same standards as the outer hull. It carries not only the personnel elevator that runs the entire length of the ship, but much of the vessel's 'central nervous system' as well. All the fiber-optic computer and intercom links and the main power and water supplies are buried within the walls of the shaft. A recessed ladder is also built into the side of the shaft for use in emergencies when the lift fails.

**Cabins:** All the cabins aboard an East Indiaman Freighter are similar in the fixtures and fittings provided. Each contains a bed locker or closet for each occupant, an intercom, a computer terminal (allowing access to the entertainment functions of the Communications program only), spacesuit storage facilities and an emergency suit for each occupant (see the section New Equipment section for further details of the emergency suit).

**Crew:** The minimum recommended number of crew beings required to run an East Indiaman is four - ship's master, pilot, astrogator, and engineer. Crew members would be expected to do more than one job. A more usual complement is seven - the exact breakdown of tasks varies from ship to ship - as this is large enough to allow some crew back up and small enough to be economic.

The ship's master is a designated crew member, often the pilot or the ship's owner, charged with overall management of the ship. The designated ship's master is granted a large number of user privileges on the computer - he or she is usually the only individual who can access any program from any part of the ship. UPF space regulations hold the ship's master responsible for safety and all other activities of the vessel.

## TRANSPOSANT SHIP

Both governments and corporations have found it necessary to displace troublesome elements in the population, and the moving of these 'transposants' proved too expensive by normal commercial means.

A Transposant East Indiaman carries the nine modified cargo pods, each containing 2000 storage berths and the attendant life support equipment. Each ship can carry up to 18,000 transposant beings - political prisoners, commercial dissidents, criminals, enforced colonial Volunteers, and corporate labor transportees - to wherever they are required. The UPF also has an ion-drive Transposant East Indiaman - UPFS S'sor - for relocating troops between bases.

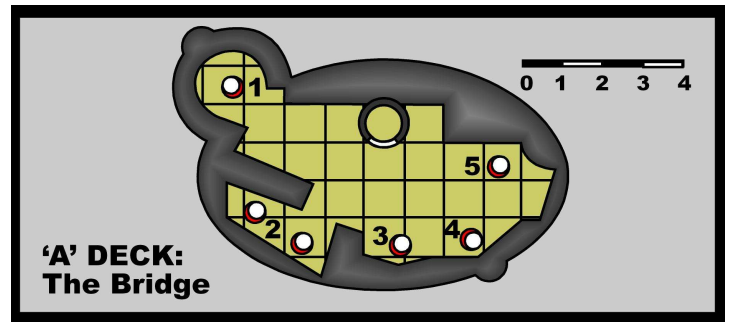

## A DECK: THE BRIDGE

**1 Astrogation:** Only the basic astrogation equipment package is provided on an East Indiaman, as these ships are intended to fly regular, well charted routes. The computer terminal allows access only to the Astrogation, Analysis and Information Storage programs

**2 Pilot's Position:** All ship control functions can be performed from this one seat, as the helm and other controls - including cargo and engine jettison controls - are within easy reach (engine jettison controls are included only if the ship has atomic drives - cargo jettison controls are standard). In addition to the master control panel, the pilot's position allows use of the videocom radio, the intercom system, the hull camera system, the radar and the hull skin sensor readouts.

All programs may normally be accessed.

The adjacent console duplicates some of the controls, allowing a co-pilot to monitor the ship's functions as well. Computer access from this console is restricted to the Drive, Alarm, Damage Control and Communications programs.

**3 Communications Position:** Usually unoccupied, this console is the central control for the ship's communication and detection equipment - the videocom radio, the intercom system, the hull camera system, the radar and the hull skin sensors. Only from here can computer data be transmitted (for example, cargo manifests too customs inspection ship) to an external system through the videocom radio.

**4 Fire Control Position:** This is the primary control position for the chin mounted laser battery (10 & 10A) and control of the weapon is normally assigned to this position. A character with Energy Weapons Gunnery skill may use his or her subskills from this console to influence the success of any fire from the laser battery.

**5 Engineer's Monitoring Position:** This console allows indirect monitoring of the ship's engineering functions through Drive, Alarm and Damage Control programs. The console also includes a separate intercom link (not connected to the central intercom) to the workpods, the engineering decks (E and G Decks) and the spacesuit radios.

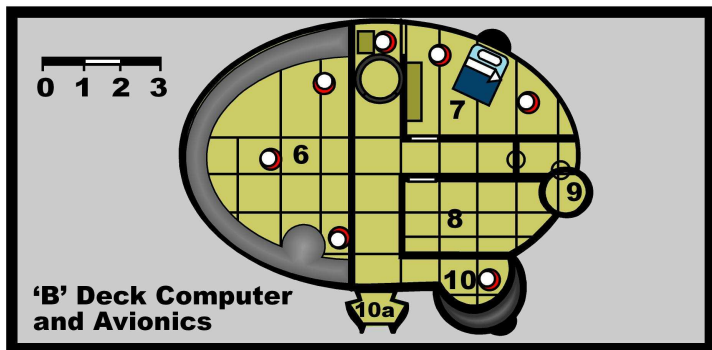

## B DECK: COMPUTER AND AVIONICS

**6 Computer Compartment:** This compartment is built to hull standards, and the door is fortified. Only the ship's master, the pilot and the engineer can enter and a security code must be entered at the Pilot's position (2) before the door will open.

The compartment contains the ship's computer, a level 4 machine, and the bulk of the ship's avionics - the electronic, detection and communications equipment. This includes the hull camera control, the radar installation, the astrogation electronics package and the videocom system.

The computer runs all the programs needed on the ship. These include Drive, Computer Lockout, Astrogation, Alarm, Damage Control, Cargo handling, Laser Battery, Skin Sensor, Life Support Installation (Ship) Security 4, Commerce 2, Communrcatrons-2, Computer Security-3, Information Storage-3, Bureaucracy 3, and Analysis 4 programs, which are supplied as standard. There is sufficient space to expand the computer to a maximum of 500 function points.

**7 Pilot's Cabin:** The pilot's cabin is deliberately placed within the ship as close as possible to the Bridge. In addition to the usual fixtures, the pilot's cabin has its own toilet facilities and a small automatic galley that can provide hot drinks and quick snacks. The Computer terminal is linked directly to the Drive and Alarm programs and is programmed to alert the off-duty pilot to any major malfunction in the ship's systems.

**8 Arms Locker:** The Arms Locker will only open under the same circumstances as the Computer Compartment (6). When delivered from the airdock, the arms locker is not usually supplied with weaponry, but a small weapons workbench is fitted.

**9 Escape Pod:** The ship's one escape pod is intended for the pilot's use. In an emergency, the pilot is expected to remain at the control console until the last possible moment and then escape aboard this pod.

**10&10A Secondary Fire Control, Laser Battery and Radar Mounting:** All the functions of the Fire Control position (4) on the bridge are duplicated here, with the added thrill of being able to watch the laser battery in action.

Major repairs to the laser battery or radar mounting (I DA) can only be made from outside the ship, but some minor circuitry can be reached from inside. If the laser battery or radar system is damaged in combat, there is a 15% chance that a repair can be made from within the ship.

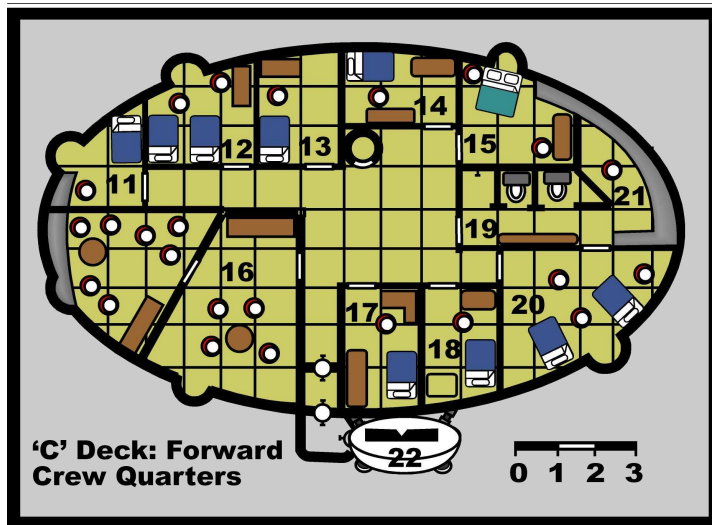

## C DECK: FORWARD CREW QUARTERS

**11-15 Crew Cabins:** Two of the cabins are for double occupancy, one (12) has two single berths, while the other (15) has a double bed installed. The beds are bolted to the floor but can be made to lower into the floor with the push of a button, a decorative panel (resembles an area rug) will move to cover the compartment. The decorative panel is padded for comfort, so crewmen can enjoy a private area to exercise as needed.

**16 Recreation Lounge:** The recreation area has a large screen computer terminal linked to the entertainment section of the Communications program. A small automatic galley, capable of providing drinks and snacks, is also fitted. In emergencies, this area can be converted into adequate - if somewhat uncomfortable - passenger space.

**17&18 Guard Cabins:** Cargo guards, provided by the cargo owners) to prevent the ship and cargo being 'lost', are allocated special cabins. These differ from normal cabins in that the doors are fortified, a weapon power clip/pack recharging station is provided and the computer terminal is allowed access to Analysis, Information Storage, Commerce, and Installation Security programs.

**19 Toilets and Shower:** The toilets and shower are standard space-going models, designed for use in zero gravity conditions.

**20&21 Sick Bay & Dispensary Allocation:** These two compartments are intended for use as a sick bay and medical office. An augmented (with a complete set of spare drugs) medkit is included when the ship is launched, along with two beds and a computer terminal.

**22 Lifeboat:** The lifeboat is a standard model (see Knight Hawks Campaign Book p 17), streamlined for planetary landings, and it has a primitive autopilot.

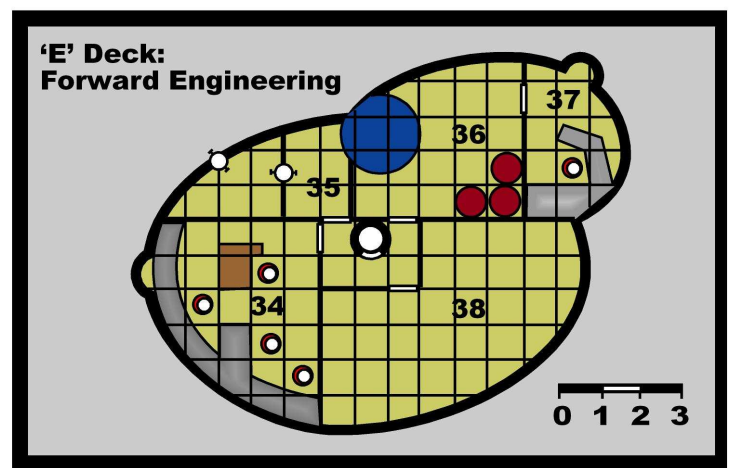
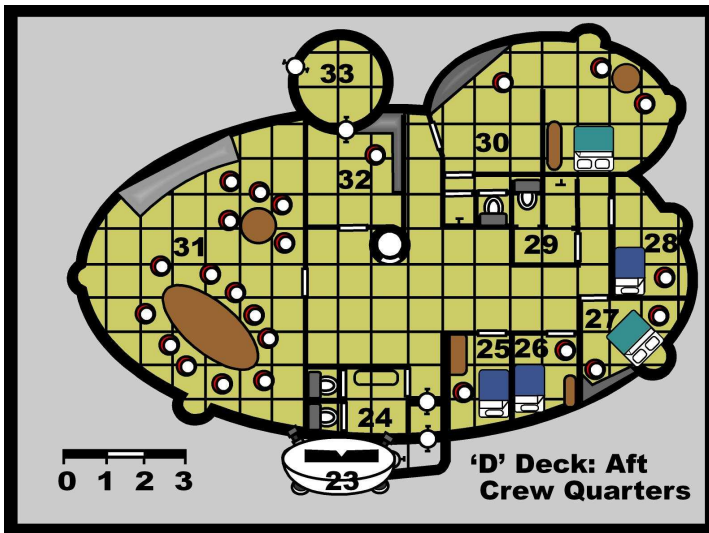

## D DECK: AFT CREW QUARTERS

**23 Lifeboat:** Identical to the lifeboat on 'C' Deck (22).

**24 Toilets:** The toilet is designed for use in zero gravity conditions as well as in the artificial gravity of ship acceleration or deceleration.

**25&26 Guard Cabins:** Identical in all respects to guard cabins 17 & 18 ('C' Deck).

**27&28 Cabins:** One of these cabins (27) is equipped for double occupancy with a double bed, while the other has a single berth.

**29 Toilet and Shower:** The toilet and shower are standard space-going models, identical to those on 'C' Decks (19).

**30 Owner's or Master's Cabin:** This is the most comfortably appointed cabin on the entire ship, and is usually decorated to suit the owner's style. The cabin has its own shower and toilet facilities, is fitted with a g-size bed, and has an automatic galley that serves any meal within its programming (the programming can be varied to suit the user's requirements). When not in use by the owner or ship's master, this cabin can be used as first class passenger accommodation.

**31 Crew Mess Area:** The mess area has the largest galley on board the ship, capable of providing any good quality standard food- or at least a reasonable imitation. The computer terminal in here is, unless there are passengers aboard, always linked to the Alarm and Installation Security programs and set to alert any crew members should an emergency occur.

**32 Forward Airlock Compartment:** In addition to a simple manual control panel for the airlock, this compartment also contains a dozen spacesuit lockers. A rack for suits storing rocket packs is fitted, along with a shower unit for cleaning of any contaminating material.

**33 Forward Airlock:** The forward airlock is used for passenger and crew transfers - whether in a station dock or between ships in flight.

## E DECK: FORWARD ENGINEERING DECK

**34 Secondary (Emergency) Bridge:** The door to this compartment is fortified, and the cardlock will only open for the ship's master, pilot or the engineer. All the functions of the bridge (A Deck) are duplicated, but to prevent the ship from being hi-jacked, the computer will only accept commands from here if those commands have been authorized by the ship's master or the pilot. However, the computer's installation Security program will automatically accept the secondary bridge as a valid control centre if 'A' Deck is no longer functional ( e.g. if the Damage Control Program reports that the hull has been breached, or the Life Support program reports that the bridge is in vacuum ).

**35 Middle Airlock:** This hatchway is usually used for the loading of passenger luggage and small items of cargo that must be carried in a pressurized environment. Unless the ship's master has authorised the transfer of luggage with the Installation Security program, this airlock will be locked - and the crew ID cards will not activate the cardlock.

**36 Forward Utility Access:** The power, water and air supply for the forward decks of the ship can all be serviced in this compartment. The majority of the compartment is taken up with the circuitry for these functions, and - most importantly of all - the back-up life support unit (also see Security Systems).

This unit is not controlled directly by the ship's main computer, but has its own designated processor ( a small level 1 computer running only a Life Support program ). The back-up LSU is normally used only in emergencies, but with both life support units running, an East Indiaman can carry a maximum of 70 beings, including the crew. Conditions in this situation would not be pleasant, but everybody would survive.

**37 Cargo Arm Control:** The computer terminal at this location is modified to include a joystick controller for the cargo loading arm (48) and release controls for the cargo pods - either 'soft' release, or to jettison the cargo. The terminal also has automatic access to the computer commerce program. The compartment is only used when cargo is being moved while the ship is docked, or as a security station because of the view of the outer hull.

**38 Luggage Space:** This is simply a pressurized hold for any luggage or delicate cargoes. It is normally kept locked during flights.

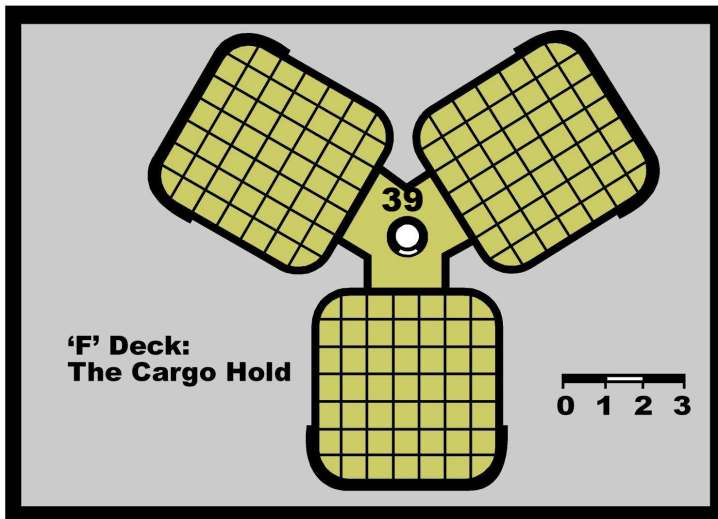

## F DECKS: CARGO DECKS

**39 Cargo Decks:** The nine cargo bays or pods on board an East Indiaman are all 14 meters square and 60 meters high and are arranged in groups of three around the central 'spine' of the ship - giving three 'cargo stacks'. The entire outer half of the cargo pod can be swung open to facilitate loading and unloading and, as a result, the standard cargo pods are not pressurized.

The cargo pods have no connection (other than simple monitoring devices) with the interior of the ship, and are detachable - in emergencies they can be jettisoned from the pilots position (2) on the bridge or Cargo Arm Control (37). This makes East Indiaman ideal for carrying high risk dangerous loads. Jettisoning pods takes 10 turns (one minute), and the jettisoning ship must change course after doing so to distance itself from the cargo pods.

Many of the larger corporations that own East Indiamen do not bother to unload individual pods from ships that are on regular scheduled flights - the entire pod is simply removed and replaced by a cargo pod containing the manifest for the ship's next destination. This minimizes the amount of time that a ship must spend in dock, as replacing a pod takes two hours. Pods that are part of the same group of three in a deck may not be worked on simultaneously.

## G DECK: CARGO DECKS

**40 Workshop:** The workshop contains sufficient tools to carry out most running repairs to the ship - the equivalent of a robcomkit, a techkit and an engineer's toolbox - although no insuit is provided. A laser powertorch - and a bench mounting to turn it into a drill or lathe cutter is also included in the standard workshop fittings, as is a power backpack. Normally the laser powertorch is plugged directly into the ship's power supply when used in here.

**41 Workpods:** Two workpods (see the Knight Hawks Campaign Book p30) are fitted as standard. Whenever a workpod is used and then repositioned in its launch cradle, diagnostic checks will be carried out by the ship's computer and the pod will be refuelled if this is required. Any repairs that are must be carried out on the pod will be displayed on the engineer's monitoring terminal on the Bridge(5) or here on G Deck (45).

**42 Main Life Support Unit:** This unit is run by the computer and is the one that is normally in operation. This one unit can supply the air, food and water requirements of up to 35 beings, although conditions would be somewhat crowded.

**43 Computer Parabatteries:** These are a final emergency backup system (one type 4 and one type 3 parabattery) to enable the computer to function - in a severely impaired way - even if the main parabatteries of the ship are exhausted. If this system becomes the only power source for the computer it will suspend all the programs except for the Life Support and Communications programs.

**44 Aft Airlock:** The airlock has a simple manual control panel. A rack for storing rocket packs is fitted, along with a shower unit for suit cleaning. Three rocket packs plus refills are provided by the ship's builders. On ships with atomic drives two engineering insuits are also provided.

**45 Engineering Monitoring:** This console monitors all of the engineering functions of the ship through the Drive, Alarm and Damage Control programs. The serviceability of other ship systems - such as the computer, workpods, camera system and the like - is also displayed here. The console also includes a separate intercom link (not connected to the ship's central intercom) to the workpods, the forward engineering deck, the engineer's monitoring position (5) on the Bridge and the spacesuit radios.

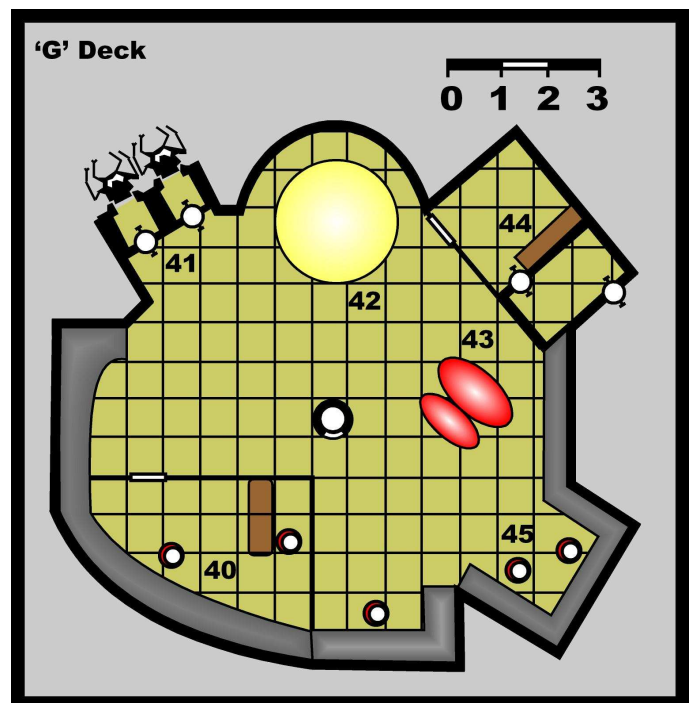

## EXTERNAL HULL FEATURES

**46 Drive Access:** The drive access tunnels are built into the engine struts and allow superficial inspection of the engine components and fuel tanks. Major repairs have to be made from outside the ship. Aboard some ships the keel engine strut has been modified to include a cubic metre of storage space, suitable for smuggling small very high value illicit cargoes

**47 Main Parabatteries:** The main parabatteries provide all the ship's power when the drives are off and the ship is not connected to an external power source (in an airlock for example). These batteries are the equivalent 15 type 4 parabatteries (a total power store of 60,000 SEU) and are automatically recharged when the drives are operational.

Because of their placement within the ship, the parabatteries have an additional use as stern armor. When an East Indiaman is fired on from directly astern, the first 15 points of hull damage may be taken as hits upon the batteries. The equivalent power storage capability of one type 4 parabattery is lost for each point of hull damage taken in this fashion.

**48 Cargo Loading Arm:** The cargo loading arm is installed on a 35 meter diameter circular track that runs around the spine of the ship between the first and second set of cargo bays. From here, the cargo arm can be extended to reach into any of the cargo pods-taking ten hours to load or unload the entire hold - or it can assist in releasing a pod, reducing the time needed to do this to one hour.

## REFEREE'S NOTES

In Knight Hawks game terms all standard East Indiamen have the following statistics.

Standard East Indiaman (Freighter)	
Hull Points	50
Weaponry	Laser Battery
Defenses	Reflective Hull
Damage Control Rating (DCR)	50
Acceleration/ Deceleration Factor (ADF)	1
Maneuver Rating (MR)	3

You can have any number of Knight Hawks-based scenarios having to do with the East Indiaman Freighter. On the page which follows, you'll notice a new Knight Hawks scenario.

It's common for freighters to have a military escort of some nature, but only when the vessel is carrying important cargo. In other cases, the "F" deck is replaced by crew compartments and the freighter becomes a make-shift troop transport, ferrying troops from location to location.

## DESIGN FAULTS ON THE EAST INDIAMAN CLASS

There are a number of design faults in the East Indiaman class that characters should not find out about, except through bitter experience. The escape pod (9) is too far away from the Bridge to be reached in a convenient time. If anyone attempts to escape from the Bridge by this route in an emergency (see Escaping from Destroyed Ships, Knight Hawks Campaign Book p37) the referee should secretly roll 2d10 This is the extra time in six-second turns that it takes the elevator to reach the bridge and then bring the character back down to 'B' Deck.

The chin mounted laser battery (10A) is so placed that it is incapable of firing on a target that is 'above' the ship or behind it. In terms of the Knight Hawks board game, this means that the laser batteries restricted to firing at targets within the shaded area of the diagram. Because it is mounted in the same place, the radar system can only 'see' objects that fall within the same zone

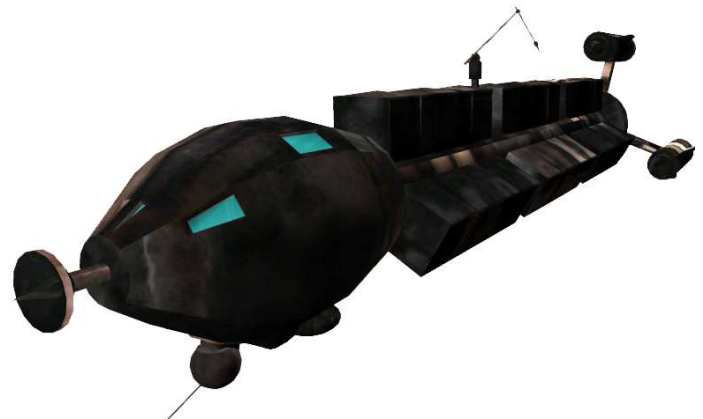
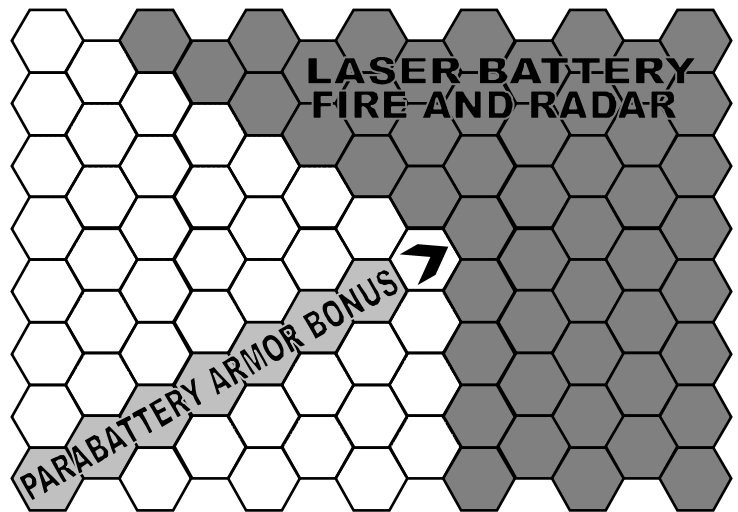

This is a Knight Hawks advanced game scenario. It requires the hex map from the Knight Hawks boxed set and several counters to represent various ships, as described below.

### BACKGROUND

An East Indiaman Medium Freighter is on its way from Gruna Garu (Hargut) to Prenglar (Gran Quivera) with a shipment of Yazirian-made gyrojet rifles for distribution to the remnants of LandFleet, stationed and awaiting weapons for their next mission.

The dread pirate Googrith-Kaar (Dralasite – complete with a patch, peg-leg, and hook for a hand –and a flair for the ultra-dramatic pirate talk of ancient humans) has caught wind of this and has mobilized his pirate fleet – which normally wouldn't prey on something this large.

Of course, UPF sent along an armed escort, but in typical armed-escort fashion, it's under-equipped for the danger it faces. As soon as the forward UPF scout detects the pirates, it sends out a request for some assistance to the UPF fleet stationed in the Prenglar system. Will the back-up arrive in time?

### SETTING UP

The two forces enter the map from opposite, short map edges. The pirate player can establish whatever speed he wants for each of his ships on the previous turn. The East Indiaman freighter and the UPF ships must begin with a speed of 5. The UPF Assault Scout (it was scouting ahead) must begin in the center of the map, unlike all other ships which must begin touching the edge of the map at opposite ends. At the start of the scenario, the freighter is in the control of the UPF side. After the ships are placed, the pirate side has initiative (is designated side A).

### The Pirate Fleet

Ship	HP	ADF	MR	DCR	Weapons	Defenses
Fighters P1,P2,P3,P4	8	4	5	30	ARx3	RH
Assault Scouts P5,P6	15	5	4	50	ARx4, LB	RH
Command Frigate P7	40	4	3	70	LC, RBx4, LB, Tx2	RH, MSx2, ICMx4

### The UPF Escort

Ship	HP	ADF	MR	DCR	Weapons	Defenses
Fighters U1,U2	8	4	5	30	ARx3	RH
Assault Scout U3	15	5	4	50	ARx4, LB	RH
Destroyer U4	50	3	3	75	LC, RBx4, LB, Tx2, EB	RH, MSx2, ICMx5

### The East Indiaman Medium Freighter

Ship	HP	ADF	MR	DCR	Weapons	Defenses
Medium Freighter F1	50	1	3	50	LB	RH

### SPECIAL RULES

**Time.** It is important for the players to keep track of the number of turns that have passed in the game since the beginning of the scenario. For simplicity, this burden falls on the side of the pirate player(s), since they begin the game with automatic initiative. Each time it's the pirate player(s) turn, add 1 to the number of turns that have passed.

**Grapple & Board.** Any ship can attempt to gain control of the East Indiaman freighter by grapple & board attempt. Fighters will be useless for this, of course, but other ships can be quite effective. To do this, a ship enters the same hex as the East Indiaman going in the same direction and speed as the freighter, ending its turn docked on top (where the LB can't shoot it!). This is more complicated than one may think, and takes careful planning and maneuvering. If this is done, the two ships move as one (whoever controls the East Indiaman moves both ships; they're connected). Each turn the grappling ship rolls d100. If less than or equal to that ship's HP rating (maximum, not current), the grappling ship gains control of the East Indiaman.

*For example: if the Command Frigate P6 successfully maneuvers into the right hex at the right direction at the right speed, the pirate player rolls d100. If the result is less than or equal to 40 (the Frigate's max HP), he has successfully captured the freighter and now controls it.*

The only way to halt the takeover is for the East Indiaman's controlling player to shake off the grapple. This is done by rolling 1d10 and rolling less than or equal to that ship's MR (that is, they must roll 3 or less). This knocks off the grappled ship, which is now moving in the same direction and speed as the East Indiaman but no longer moving *with* that ship.

**A Spy Among Us.** Unknown to the captain of the East Indiaman Class Medium Freighter, the pirate Googrith-Kaar has planted a spy in the midst of that crew (that's why he's emboldened to raid a ship this large). He has been spending his entire mission acquiring the means by which to gain control of the freighter. The pirate player(s) may, at any point, call on this spy to act. When this happens, roll 2d10. If the result is less than the number of turns that have passed since the beginning of the scenario, the spy is successful and the Pirate player now controls the East Indiaman. This can only be attempted once, successful or not. The UPF player might figure things out if the pirate team seems to be waiting for something...

**Calling for Reinforcements.** On turn 20, the UPF's reinforcements arrive, traveling any speed the UPF player desires. They'll come from the pirate's side of the map (from the direction the East Indiaman freighter was heading)! This will sandwich the pirates between two dangerous groups. The pirate player need not keep track of the passage of turns at this point; it's the last timed event in the scenario. The reinforcements will be as follows:

### UPF Reinforcements

Ship	HP	ADF	MR	DCR	Weapons	Defenses
Fighters U5,U6	8	4	5	30	ARx3	RH
Destroyer U7	50	3	3	75	LC, RBx4, LB, Tx2, EB	RH, MSx2, ICMx5

### VICTORY CONDITIONS

Unlike many scenarios, the victor isn't the side who eliminates all of the opponents. The victor is whoever owns the East Indiaman freighter when it travels off the map in the opposite direction from where the controlling player started the scenario. Thus, if the pirate player controls it when it exits the map in the direction the UPF side started, then the pirate fleet is the victor. If the East Indiaman is destroyed for any reason, nobody wins and the scenario ends in a tie.



# PRENGLAR SYSTEM

Allen Trussel

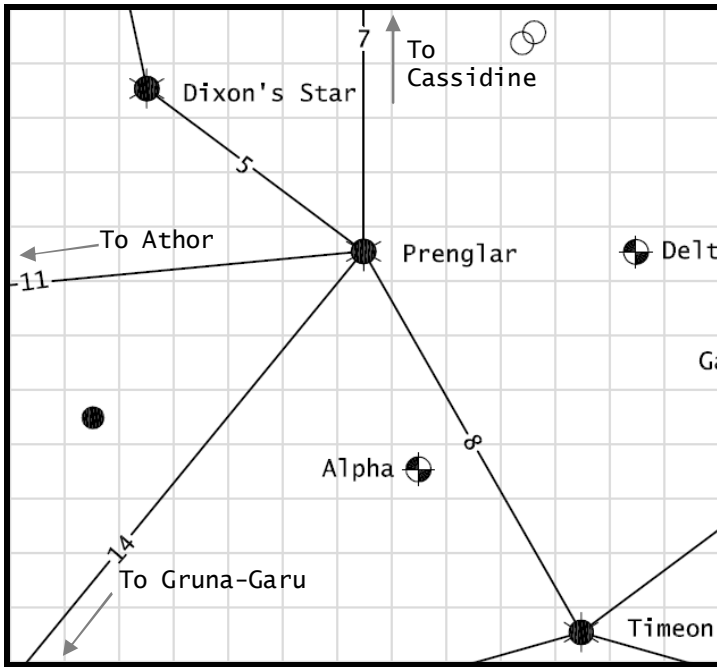

The founding of the United Planetary Federation (UPF) took place on Gran Quivera after these events. Lengthy meetings were called and attended by members of all the major races. After much debate, a pact of mutual protection and trade, while still allowing self-governance of individual worlds and systems was established. With its central location, it was agreed that Gran Quivera would be the center of this new governmental body, and the Council of Worlds and the Office of the Prime Minister can both be found here as well as many other UPF governmental buildings.

After the war, many humans chose to colonize Morgaine's World. This large planet with its beautiful rings is an arid land, and harsh in climate. These pioneers struggled long to survive, and little assistance was available from Gran Quivera, which was still recovering from the war. When the Capellan Free Merchants (CFM) arrived, they were greeted by both worlds with great appreciation, to the consternation of the PGC.

When the Blue Plague arrived, there was great fear across the system. Both Gran Quivera and Morgaine's World banned all travel within the system, which hindered efforts to find a cure. In hindsight, if the authorities had taken some simple precautions, the cure eventually discovered in the MSO Center on Morgaine's World would have been much sooner and more lives could have been saved.

## THE PEOPLE

As the hub of the UPF, the people of the Prenglar system are a diverse lot. Members of all known races can be found here, most working in various government positions, or for PGC. The peoples of Gran Quivera are very cosmopolitan, and generally highly educated, although they can evidence a certain haughtiness. Morgaine's World is still largely inhabited by humans of pioneer tradition, and have a very enduring spirit. Morgainers, as they are called, are independent, and are mavericks in all endeavors. With such a large world, with vast continents, they tend to say that "everything's bigger on Morgaine's World!"

## PLACES OF INTEREST

- **Port Loren:** perhaps the earliest colony founded on Gran Quivera, this sprawling city is home to the Council of Worlds, the Office of the Prime Minister, the headquarters of PGC, Galactic Task Force Inc., and Star Law, as well as many other corporations and government agencies. Port Loren is often cited as "The Center of the Galaxy", although this is hardly true. The city sprawl is so vast that over one-third of the population lives within it.

## STAR SYSTEM

Star Type.....	F9 White Main Sequence
Radius.....	$7.68 \times 10^5$ km (1.10 Sol)
Mass.....	$2.19 \times 10^{30}$ kg (1.10 Sol)
Temperature.....	6,140K degrees Kelvin
Luminosity.....	$3.5 \times 10^{26}$ W (1.67 Sol)

## HISTORY

One of the first systems discovered by humans in the Age of Exploration, Prenglar was found to be a boon to the wandering humans. Finding so many habitable worlds in one system, these early explorers quickly settled on the fifth planet, which they named Gran Quivera. Using this as their main colony, humans explored further into the local group, encountering other species and finding new worlds to settle.

One of the earliest corporations to form on Gran Quivera was Pan-Galactic Corporation, (PGC) originally created to aid in colonization and exploration. As human colonies grew, and relations with other races firmed, PGC expanded its mandate to include travel, mining, freight and more, eventually becoming the first Megacorporation.

During the First Sathar War, the Prenglar system saw the Battle of Two Fleets, in which the great fleet of the First Muster faced the Sathar fleet in a pitched battle that would decide the fate of the Frontier. Outnumbered and outgunned, the masterful Admiral Vincent Morgaine used superior tactics to overcome the Sathar fleet. Sadly, Admiral Morgaine was mortally wounded in the conflict. The fourth planet in the system was named Morgaine's World in his honor.

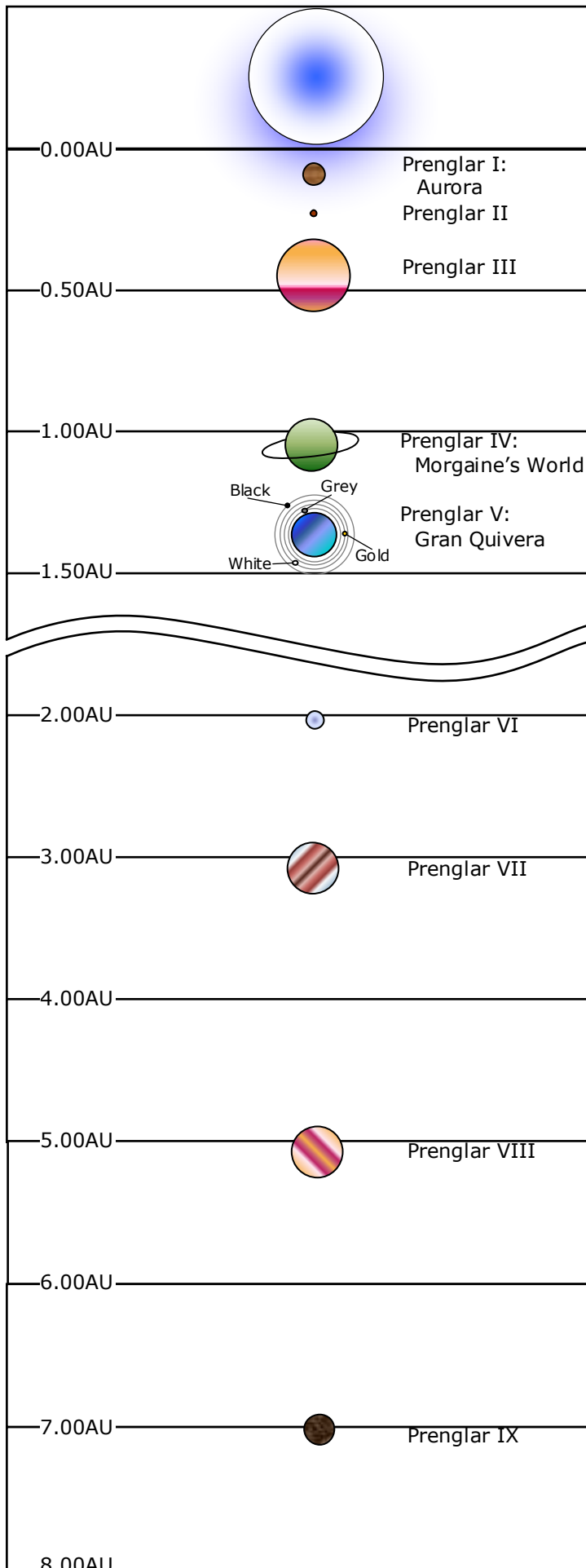

• **Gollwin Academy:** orbiting Morgaine's World, this station is the preeminent training facility for the Spacefleet and Star Law's Ranger Corps. Named for Admiral James Gollwin, the Academy produces the finest officers and rangers, as well as providing specialized training in many starship disciplines. Military research also takes place at Gollwin, and some of the greatest advances in starship technology have been discovered here.

• **Sanctuary Station:** this rest and relaxation station is arguably the finest in the Frontier. The best amenities, and a spectacular view of Morgaine's World below make it a destination for beings from everywhere in the UPF and Rim. Spacefleet officers are given a great discount at Sanctuary Station!

## PLANETS

### PRENGLAR I (Aurora)

Type ..... Rocky desert, hot  
 Orbital Radius..... 44.64 million km (0.3 AU)  
 Local Year..... 119 standard days (60.71 local days)  
 Local Day..... 49 standard hours  
 Gravity ..... 0.61  
 Diameter ..... 7,000 km

**Notes:**

This hot, rocky planet has a thin atmosphere of noble gases and a strong magnetic field. This results in spectacular auroral displays, hence the planet's name. It is otherwise notable only for its mineral wealth, with small mining colonies operated by PGC and other interests.

### PRENGLAR II

Type ..... Airless rock  
 Orbital Radius..... 65.47 million km (0.44 AU)  
 Local Year..... 281 standard days (75.54 local days)  
 Local Day..... 93 standard hours  
 Gravity ..... 0.13  
 Diameter ..... 2,000 km

**Notes:**

This tiny ball of rock has nothing of interest and little mineral wealth. Its minimal gravity makes any mining efforts futile.

### PRENGLAR III

Type ..... Jovian  
 Orbital Radius..... 99.7 million km (0.67 AU)  
 Local Year..... 494 standard days (363.24 local days)  
 Local Day..... 34 standard hours  
 Gravity ..... 3.12  
 Diameter ..... 64,000 km

**Notes:**

This is small gas giant, with 5 large moons in orbit. Two of these moons (IIIa and III c) have enough gravity and minerals to support some mining, but neither has a breathable atmosphere nor habitable temperatures. Enclosed mines are found on both moons.



## PRENGLAR IV (Morgaine's World)

Type.....Terrestrial, arid, ringed  
 Orbital Radius.....157.73 million km (1.06 AU)  
 Local Year..... 223 standard days (139.38 local days)  
 Local Day..... 40 standard hours  
 Gravity..... 1.5  
 Diameter ..... 16,700 km

### Habitable World Data:

Hydrosphere	20% water (0.12% ice)
Atmosphere	76% nitrogen, 13% oxygen, 1% carbon dioxide, trace others.
Land Area	One large pangeatic continent, and two small island continents with numerous islands.
Climate	Warm and arid, with large deserts, plains and scrublands.
Trade	Various business and industrial ventures, especially in the fields of medicine and food, as well as extensive agriculture.
Government	Representative
Population	Moderate human (approximately 5.2 billion)

### Native life:

A wide variety of wildlife exists on Morgaine's World, and strict regulations are enforced to keep non-native species out. The beautifully plumed *imukou* bird is a prized find here, often found among the *kochor* trees, equally valued for their fine hardwood. The *chyrr*, a rodent pest found throughout the planet in a variety of subspecies, is the bane of farmers. This gopher-like creature eats virtually any plant, and is highly resistant to all known pesticides. Of greater concern is the *keddith*, a predatory flightless bird (the *chyrr*'s only major predator), the *tevnarl* (or Morgaine's Lion), and the poisonous, fungal *drape moss*.

Author's Note: the *keddith*, *tevnarl* and *drape moss* are detailed separately; the others are basically interesting, but harmless flora and fauna.

## PRENGLAR V (Gran Quivera)

Type..... Terrestrial  
 Orbital Radius.....200.88 million km (1.35 AU)  
 Local Year..... 375 standard days (625 local days)  
 Local Day..... 15 standard hours  
 Gravity..... 1.0  
 Diameter ..... 12,500 km

### Habitable World Data:

Hydrosphere	60% water (9.6% ice)
Atmosphere	73% nitrogen, 18% oxygen, 2% carbon dioxide, trace others
Land Area	Six large continents, with a few dozen major islands.
Climate	Varied, with large temperate regions.
Trade	Heavy business and industry, especially electronics, engineering, manufacturing, and basic goods.
Government	Representative
Population	Heavy mixed (all of the major races, and many minor races; approx. 16.35 billion).

### Native life:

With the heavy industrialization of Gran Quivera, few native life forms remain, save for in a few nature preserves. Among these are most notably the *uvu* tree, which produces a tasty fruit, and the deadly *chameleon snake*. Although small in size, the *chameleon snake*'s highly toxic venom can bring down most beings.

**Editor's Note:** Gran Quivera is blessed with four moons, two of which are quite useful. They are unimaginatively named after the coloration of their topsoil when viewed from the surface of Gran Quivera: Grey, Gold, White, and Black. Black is visible only because it blots out the stars it passes by, and is a moon most dark. Grey is full of deep, rich, minerals and is mined regularly by Pan Galactic Corporation, though some mineral rights belong to private groups constantly beset upon by PGC purchase offers. White has secret military uses - research & development. The Assault Scout was said to have been developed here.

## PRENGLAR VI

Type..... Icy planetoid  
 Orbital Radius ..... 321.4 million km (2.16 AU)  
 Local Year ..... 631 standard days (1434 local days)  
 Local Day ..... 11 standard hours  
 Gravity ..... 0.05  
 Diameter ..... 2,000 km

### Notes:

This is little more than an icy chunk of stellar debris.

## PRENGLAR VII

Type..... Sub-jovian  
 Orbital Radius ..... 482.11 million km (3.24 AU)  
 Local Year ..... 405 standard days (142.6 local days)  
 Local Day ..... 71 standard hours  
 Gravity ..... 0.47  
 Diameter ..... 15,000 km

### Notes:

A thick atmosphere of ammonia and methane shrouds the rocky surface of this frigid world.

## PRENGLAR VIII

Type..... Sub-jovian  
 Orbital Radius ..... 758.9 million km (5.1 AU)  
 Local Year ..... 680 standard days (186.81 local days)  
 Local Day ..... 91 standard hours  
 Gravity ..... 0.18  
 Diameter ..... 23,000 km

### Notes:

Larger than its sister world Prenlar VII, this is a similar planet; cold, dark and toxic. It has two icy moons, which are otherwise unremarkable.

## PRENGLAR IX

Type..... Rocky desert, cold  
 Orbital Radius ..... 1075.41 million km (7.16 AU)  
 Local Year ..... 752 standard days (400 local days)  
 Local Day ..... 47 standard hours  
 Gravity ..... 0.88  
 Diameter ..... 14,000 km

### Notes:

Despite having a dense atmosphere, this world is too cold and dark to support life. There is some light mining and industry here, as well as a military training outpost. Three small moons orbit the planet. ★

## FIRST SATHAR WAR

Mark Singleton

GREAT WAR STRATEGIES,  
REAL OR IMAGINED?*By Dr Helgan Kalzid*

Years ago the species known to us as the Sathar, came seemingly from nowhere to plunge the Frontier into a war of epic proportions. Or did they? This examination will follow the three phases of the war, the initial surprise, the continued attack and the "retreat", I will then offer my comments and then conclude with a summation. I do warn, that some of the material presented may challenge what you hold as inescapable truth, but the victor, always writes the truth.

The system of Zebulon had just been established as being close enough to travel to and thus was given a name, but it took decades for any Frontiersman to attempt it (in fact we are just getting to it now). Just as we were getting comfortable with our surroundings and general life in the Frontier, another species made its presence known. We call them Sathar, what they call themselves we don't know but we do know they took offense to our presence. Without warning, ships appeared just off of Pale and moved in to attack anything and everything in sight. If it were not for the fact that two freighters belonging to the Pan-Galactic Corporation had already completed calculations and were powering up, no one would have escaped. Several shuttles were able to dock with them and these few represent all that escaped, but not all that survived.

Planet-side, most of the citizens fled to the surrounding area when news of the attack first reached them. The exploding ships could now be seen in the sky and the debris streaked down like fiery rain. These survivors would unknowingly be the only force at the end of the war to rid the captured planets of the vile creatures.

With Pale taken care of, the Sathar Fleet (SF) deposited a small contingent of troops on the surface and moved on to New Pale. With virtually nothing there to slow them down, they again placed some troops on the surface and moved on to their next target. This 'surprise' phase was accomplished in under a day, several freighters, system ships and shuttles were destroyed (exact number unknown) and many lives were lost. Warning went out to Dixon's Star as soon as the hostility of the Sathar fleet was determined in an effort to keep ships away from the system. One ship was in transit but arrived after the SF had moved on and was able to provide some assistance in recovering trapped personnel from dead and dying ships.

With warning sent and received, the people of the Frontier banded together to form a fleet of what combat ready ships could be gathered as quickly as possible. As every person in the Frontier knows, command was given to a Human, Vincent Morgaine. Now we have a fleet and an 'Admiral', so what now? With some quick glances at the current star chart, Morgaine made the determination that there were two courses of action available. First option, the SF moves on to Dixon's Star, which is 5ly from Truane's Star, meaning that it takes 50 hrs for calculations and 5 days of travel, so hypothetically he has 7.5 days before they would emerge in the system. The second possibility is that the Sathar travel to Cassidine, which is also 5ly from Truane's Star, so the



bottom line is that in 7.5 days the SF could be at their next target. Prenglar is 7ly from Cassidine and 5ly from Dixon's Star, time to target is 10.5 days for Cassidine and 7.5 days to Dixon's Star. So the variables to consider are how long will the SF stay in the Truane's Star system, how fast can they calculate jump data and how fast are their ships? A lot of variables, especially when you consider that it could take up to 10.5 days to correct a mistake in logic.

The fleet moved out for Cassidine (this was hotly contested as being the wrong choice, but Morgaine is rumoured to have stated that the Sathar did not have our star charts and thus did not know where they could and could not go), one ship was also dispatched to Dixon's Star to act as an outpost (OP) in the event that the SF chose it as a target instead. Of note here, with out knowing what the composition or capabilities of the SF were, Morgaine only took half of his available fleet and hoped that additional ships could meet him in Cassidine from Dramune or Madderly's Star. This was a compromise largely due to the fact that if the wrong system was chosen, they would not have enough time to get back to Prenglar which would result in Morgaine being totally out of position and begin playing a losing game of catch up. The Frontier Fleet (FF) reached Cassidine and no SF was in sight, mildly concerned Morgaine called his outpost in Dixon's Star, they signal back that they are in location, but no Sathar. Assessing the battle area, Morgaine decided to use the asteroid belt on the edge of the system towards Truane's Star in order to see if he could conceal the fleet from the SF and strike the rear. Keep in mind that Morgaine's command ship was a "heavy" cruiser and one of the few ships made for battle.

When the SF entered the system Morgaine was proven correct in his gamble, but why did it take them so long to get there? Morgaine almost expected to emerge into a battle and instead he was waiting for them, do they have slower engines or astrogation computers? Putting that aside, he waited for his chance to strike the weaker (hypothetically) end of the SF. This gave the FF the first chance to see the ships of the enemy and they quickly determined that these are battle craft, designed to fight and that they outgun anything the FF has. This is not the best situation to be in, since they also outnumbered the FF by a fair margin. Approximately one third of the SF was destroyed in less than an hour, the Sathar suddenly jumped out of system in the same direction they came. Losses to Morgaine's fleet were relatively minor, but now there was concern. FF ships dump data on a jump and have to recalculate, but it seems that the SF data might be saved and valid for a quick return trip, or is there something else at work here? Did they plan an escape route back before jumping in? This battle added more questions instead of answering them.

The next move was easy to make, taking the FF plus the few additions that joined it in Cassidine, Morgaine returned to Prenglar. The OP reports (while Morgaine is in FTL travel) that the SF is in system and striking anything and everything that did not already flee. The OP went silent in mid-transmission and the waiting game began. Reforming his fleet and adding some new arrivals, the fleet was almost back to full strength (approximately 7/8 by estimation) and again choice of the engagement area was his, open space. Days later, the SF emerged in the Prenglar system and the two near equal fleets moved in for the final battle.

This battle lasted hours and saw the near total destruction of both fleets. The remaining jump capable SF ships are reported as "scattering in all directions". Attempts to recover the crippled Sathar ships resulted in self-destruction of them and the boarding vessel, a much more common event than we have been lead to believe. The remainder were then destroyed in place without further attempts to capture. In this battle, Morgaine and his command ship were lost with all hands and the war was over. Or was it?

We have covered the "known" facts of the Great War, but what of the unknown? Above, a few questions should be sitting in the back of your mind, and I can assure you that you will discover a few more in this next portion. We know nothing about the Sathar, so we only have what we have observed as a basis to create fact. First, let us deal with the facts then we will move into the other "facts".

FTL travel is taken as 1 day per light year travelled. This is a constant to us now and has been a constant since all four of our species took to the stars. Calculations take 10 hours per light year to be travelled, we can do them faster at a risk of misjump but in military operations, you want to hit what you are aiming at. So if we return to the invasion and take the time spent on the attack of Truane's Star as one hour for one hour with the planning and raising of the FF, the SF could have been in either Cassidine or Dixon's Star after 50 hours of calculations and 5 days travel totalling 7.5 days. With the fleet in Prenglar, quick calculations would put the fleet in Dixon's Star in 7.5 days or Cassidine in 10.5 days. These are all facts, so why move the fleet to Cassidine and potentially arrive 3 days after the Sathar, instead of moving to Dixon's Star and into a possible meeting engagement? Not the best option, but when trying to stop an invasion, it is usually best to get somewhere before the enemy. Keep this in your mind and read on.

Using our own star charts as a reference, if we moved the FF to Cassidine and the SF moved to Dixon's Star, they would be in Prenglar before the FF could return. Potentially the Sathar could gain two systems and be enroute to a third before we knew what was going on. There is one possible fact to insert here and that is that the Sathar came from beyond the Zebulon system, so they have knowledge of other systems and routes. This leads one to think that the choice of Cassidine over Dixon's Star as a target was made as simply as how one would determine which shoe to put on first in the morning. This leads to a very frightening realization in the way the war was waged and won. It also raises the potential that the Sathar knew it was not a "known" route, this would lead to the possibilities that either they had spies already in place or that they had scouted it out prior to the



invasion. Also keep this in the back of your mind and read on.

The next fact we have is that the Sathar made Cassidine the second target system and played into the huge gamble that Morgaine made. Further to that, they bypassed the asteroid field and homed in on the habited planet. Was this because they were focused on the planet, or was it that they had reason to believe that the FF would move to Dixon's Star? The attack on the rear of the SF fleet was swift and decisive, so much so that the Sathar left the system in short order. So this brings us to the next odd realization, the Sathar can either calculate jumps in under an hour, or they have computers that can save a return trajectory, or they arrived after Morgaine because they plotted an exit vector before departing Truane's Star. The third option would change the time of travel to Cassidine from 7.5 days, to 10 days. This may begin to explain the way the FF was able to arrive first, despite the longer distance to travel. Maybe add a day to the calculations to account for the fact that they were functioning based on calculated data and not observed information and you would get the FF arriving first. This "fact" leads you to the conclusion that the Sathar can store two sets of data in an astrogation computer, this is a very interesting and frightening conclusion. The dangers of these assumptions are that we are making the data fit our observations and extrapolations, very dangerous if one wants to draw accurate conclusions.

It certainly adds some interesting possibilities to the pile of "facts". It is generally accepted that the Sathar returned to Truane's Star and moved on to Dixon's Star. I say "generally accepted" since there were no ships in the Truane's Star system to observe this occurrence. This trip would have taken 5 days travel, then 50 hours of calculations and 5 more days of travel. Potentially add another 50 hours plus 1 day if they plotted an escape vector back for each move. The FF returned to Prenglar taking 10.5 days in travel time to do so. Morgaine received word from the OP in Dixon's Star (while enroute to Prenglar) that the SF was attacking there and devastating the area, taking no prisoners and then the OP went silent. So the SF was on time for a direct move from Truane's Star with no time taken for reverse calculations (or whatever they were doing), maybe. So if the SF was in Dixon's Star at approximately 12.5 days after leaving Cassidine, that would mean that Morgaine's fleet would have been out of FTL and in Prenglar for 2 days, or were they? How could he have received this information enroute to Prenglar if he left immediately after the battle?

We know that the FF tried to board several disabled Sathar vessels and that all attempts were met with destruction of both ships. We also know that attempts were made to recover Frontier personnel and that after seeing the SF up close and having experienced it's capabilities, Morgaine waited for reinforcements. This may be where the realization of Morgaine's plan to stay in Cassidine first appears. Hypothesizing that the Sathar would take at least 12.5 days to get to Prenglar from Cassidine (if they travelled to Dixon's Star, up to 20 days if they went back to Truane's Star first) and he knew that he could get back to Prenglar in less than that, he used as much time as he could to allow ships enroute from Dramune and Madderly's Star to join the fleet. This estimated time buffer would be longer if he could be guaranteed that they always plotted an exit route before moving to a new system. Unfortunately, at this point it has only happened once and is not yet a pattern. Having used up all of his estimated time, Morgaine moved the now reinforced FF to Prenglar to meet the SF in what he now calculated to be better odds, but still on the disadvantaged side (not many ships made the effort).

Ships from the Timeon, Athor and Gruna Garu systems were dispatched (or at least asked to go) to Prenglar as soon as the decision to form a fleet was made and so when Morgaine emerged, he had a fleet with firepower on par with the SF. Things were looking up. The Sathar emerged 21 days after departing Cassidine, and 8.5 after contact with the OP in Dixon's Star was lost. The fiercest fight anyone had ever seen was about

to begin and it would rage on for hours. After all was said and done, the SF as an effective fighting force was destroyed, but so was the FF. There were some surviving FTL capable Sathar ships that "scattered in all directions", as one of the more reliable sources states.

This raises another interesting question on the established facts. We know the Sathar were not moving as "fast" as we were, unfortunately not one astrogation computer was successfully salvaged from a ship to show us if this was because of slow calculation ability or that they were plotting return flights as well. What is of note, is that the Sathar took almost exactly the correct time for a route from Cassidine to Prenglar via Truane's Star in a series of one way plots and jumps, so this could support the 'return trajectory calculation' hypothesis for the delayed appearance in Cassidine. The technology of the engines seemed to be equal to our own, but again not one intact engine or drive system was ever recovered. But if the retreating Sathar ships went "in all directions", where did they go and how did they get there?

There is nothing in the records (such that they are) to suggest that the Frontier ships pursued the fleeing Sathar, so it is possible that they simply travelled to a spot, calculated a jump from there and returned to wherever they came from. Sounds nice and simple, but I don't think it is. We have no way of knowing if they went back, since everything between Prenglar and Zebulon was destroyed. We know that the Sathar left troops on every planet they attacked, but not enough to hold against a determined ground attack. In fact, these were taken care of by the local citizenry of the respective planets, so why do it? If we accurately pieced together estimates from the few surviving records, the numbers on each planet were in the dozens, not hundreds or thousands, as one would expect from an invasion fleet.

In recent years, Star Law has been finding Sathar agents in some rather unusual places, in very secure jobs and in very high profile positions. What if the very Sathar that fled the final battle trained these agents? We have no idea how long they live, but what if it were hundreds of years? Dralasites can live for 250 years so it is not out of the realm of possibilities that the Sathar could match or even exceed these ages. To extrapolate further on this, what if the whole point of the war was to penetrate as deep as possible, disperse as many spies as possible and then erode us from within?

Let us really look at the numbers of the war, it only involved four systems and resulted in the devastation of three planets, this is hardly a proper invasion. Our fleet did not consist of every available ship in the Frontier; it just consisted of the ones that could make it into the battle areas. By far, Humans suffered the most casualties as two of the three planets were Human settlements and the third was a mix of all four Frontier species. Had the Humans been alone and had all of the Human ships in the Frontier been gathered in one place, I think they would have provided the Sathar with a fleet of equal strength in terms of firepower and numbers. With that in mind, again by extrapolation, it is not possible that the attack was not representative of the entirety of the Sathar capability? What if this was only one of other species in a similar arrangement to ours, or one caste or clan of many? I think the war was actually a battle that was designed to get Sathar spies and agents deep into Frontier space with the intent to weaken us for the real war.

In summary and conclusion, the Great War involved much less than 1/4 of the Frontier population, it spanned only four systems and devastated only three planets. Wild gambles were taken and assumptions were made that paid off in the end. The Sathar did not employ consistent tactics and often appeared to alter them in mid-stride. We have no way of knowing what the Sathar did after their final defeat at Prenglar, but it is clear that they have not left us alone. I don't think we won a war, I think we simply ended the first phase of a larger plan. The Sathar will return, but when and from where...



# PLANET OF MYSTERY

*R. Kevin Smoot*

**Author's Note:** The following race description assumes that the events of 'The Voltornus Adventure' were successfully resolved, and some several years have since past, allowing for the integration of these races into frontier life. In addition to the Mechanon expansion into space, other races of Voltornus have also ventured out. The Eorna were prodigious genetic manipulators and have successfully molded a few races worthy to travel the stars.

## ARBOREAN

The feathered Arboreans originally hail from the planet Voltornus of the Zebulon system. They are yet another genetic experiment of the remnant Eorna race, engineered to fight against the Sathar threat.

### PHYSICAL STRUCTURE

Arboreans are an intelligent species of genetically manipulated bipedal bird-like creatures. They are just over a meter in height and are covered by feathered plumage and have wing-like arms ending with a manipulating hand. Despite the wing-arms, Arboreans are technically flightless, only capable of gliding in a manner similar to the Yazirians. Casual movement is done on all fours, although they can move about on their rear legs as well when hand-held equipment becomes necessary.

The plumage varies greatly on space-faring individuals of the species, since the individuals can come from any particular community of Arboreans. Separate communities of the birdlike race all seem to share a common pattern of color and feather types according to their environment. There are communities that appear rather hawkish and other communities that appear owl-like, each with appropriate coloration. Arboreans from communities in tropical climates often have bright colorations of reds, blues, and greens. Despite the exact feathering combinations, all Arboreans are of a common race, genetically similar. It takes only the span of a single generation in most cases for Arborean young to adapt their plumage to match their neighbors. In all cases, male plumage is more striking than the corresponding females of the race. When excited, angry, or otherwise stimulated their feathers often stand erect, most pronouncedly on their head and down their spine.

The head of an Arborean has a large beak, curved downward to a point appearing somewhat like a cross between a bird-of-prey and a parrot-like beak. The beak is sharp but not well designed for chewing as the Arborean diet consists mostly of meat, supplemented by various fruits and nuts. Bright, forward facing eyes dominate the rest of their face. Arboreans can turn

their heads almost all the way around in a manner similar to owls.

The body of an Arborean is slight, almost spindly. They are well muscled, but the musculature is designed for fine motor control used while maneuvering in the air, and not for feats of lifting strength. Bones throughout their body have hollow spaces to keep overall weight very low.

Each wing of the Arborean ends with a hand-like appendage that is quite dextrous. These digits can hold things and do fine manipulations as well as any human hand. When fully spread, the Arborean wingspan is over 2 meters, and enables the Arboreans to glide, and they can keep aloft nearly indefinitely in their native mountain habitat where they ride the strong constant updrafts of the wind.

The legs of Arboreans are quite strong and end in feet with talons. These feet can also grasp items strongly, but lack the fine motor control necessary for many tools (such as firearms). Arboreans standing upright walk in a rather ungainly manner. It is more comfortable for an Arborean to walk on all fours in a manner much like a bat would crawl about. Despite the crawling movement, Arboreans are still mostly erect when moving about due to the length of their wing arms.

### SENSES

The primary sensory organ for Arboreans is their keen eyesight. As a predatory avian, they can see even minute details even at substantial distances. As such, Arboreans make superb sharpshooters, able to hit distant targets, limited more so by the effective ranges of the weapons they wield.

Arborean smell and taste senses are not nearly as developed as some other races. The senses of touch and hearing are roughly equivalent to a human's senses.

### SPEECH

Native Arborean speech consists of a number of shrieks, screeches and similar calls. Despite the difficulties that the various frontier races have in producing these speech patterns, the Arboreans can readily reproduce the sounds of most other frontier languages with ease.

The name 'Arborean' is a Pan Galactic term, as the native speech term used is very difficult for most other races to articulate. Even if a frontier race understands native Arborean speech, they are not likely to be able

to actually speak it, usually resorting to a polyvox to express terms in the native Arborean speech. It is understandably quite rare for non-Arboreans to learn the language.

## SOCIETY AND CUSTOMS

On Volturnus, the Arboreans live simple lives as hunters and gatherers, keeping to a tribal society. Events surrounding the Frontier expansion on Volturnus had largely left the Arboreans alone in their mountain homes. It was only when pirate mining operations encroached on their territories did the race of bird-men begin to take interest in the larger world and Frontier Space beyond.

The basic social unit of Arboreans is their immediate family. The nest-mates keep contact with each other whenever possible, sharing information and details of life, although displays of affection are unknown. It is not a matter of such displays being taboo. They simply do not have those emotions, whether this is rooted in physiology or just in their mental psychology. A few rare individuals have learned to show affection, but it is debated that they are simply emulating other species' behaviors in an attempt to fit in.

Beyond the nest family, the next social grouping is the 'roost' which consists of an area or region where many nests are found in proximity. A leader or council of leaders is chosen to decide on matters that affect the region. Beyond these roosts, the Arboreans have not created larger social structures such as states or nations. However, the Arboreans do find their places within the social organizations of the other frontier races quite easily.

Arboreans have few laws. The roost leaders make major decisions regarding misconduct, and most Arboreans follow their lead. Occasionally a particularly poor leader is removed from leadership, but this is a rare occurrence, occurring when a grievous mistake was made. Banishments are common, but capital punishment is not unheard of. Despite their own lack of distinct legal or social structures, Arboreans living among other races and cultures do not have much trouble adjusting, due to their keen observational skills. Even complex Vrusk legal systems are navigable by Arboreans.

When it comes to occupations, the Arboreans gravitate to adventuring and military endeavors, as scouting and

reconnaissance comes naturally to them. Piloting, whether in airships or spacecraft, is another often chosen profession. Work with any of the major corporations is easily found by Arboreans seeking employment.

## ATTITUDES

The Arboreans are fond of the other frontier races, but it is often rather difficult to see. Being avian, the Arboreans do not have much understanding of affection or similar emotional displays. They appreciate camaraderie but simply do not have the faculties for much in the way of affection or feelings of endearment. One should feel quite satisfied when the Arborean does not display hostility, as this likely means that the Arborean actually likes you. On the other hand, it is quite apparent when an Arborean does not like someone. Their feathers will stand on end, and the Arboreans are known to squawk directly in the face of disliked individuals in a rather provocative manner. This need not be actively hostile or indicative of an immediate attack, but it should telegraph clearly when a creature is not acceptable to the Arborean.

The Vrusk appreciate the Arborean's ability to understand the intricate cultures common to Vrusk. This leads to almost immediate acceptance in their complex society. There are many Arborean operatives in Vrusk companies, often with much authority.

Yazirians like the Arboreans because they share a love of riding the currents. A Yazirian and an Arborean can spend hours relating with each other about the joys of flight. The Yazirians also appreciate the Arborean understanding of battle tactics.

Humans and Dralasites are a little less disposed to the avian race. There are few similarities in lifestyle, and even less comprehension regarding the Arborean lack of endearment feelings. They can often overcome their feelings once they get accustomed to the Arborean attitude, but it takes time.

The Arboreans have a great hatred of the Sathar (and related races such as the S'sessu). This is likely a

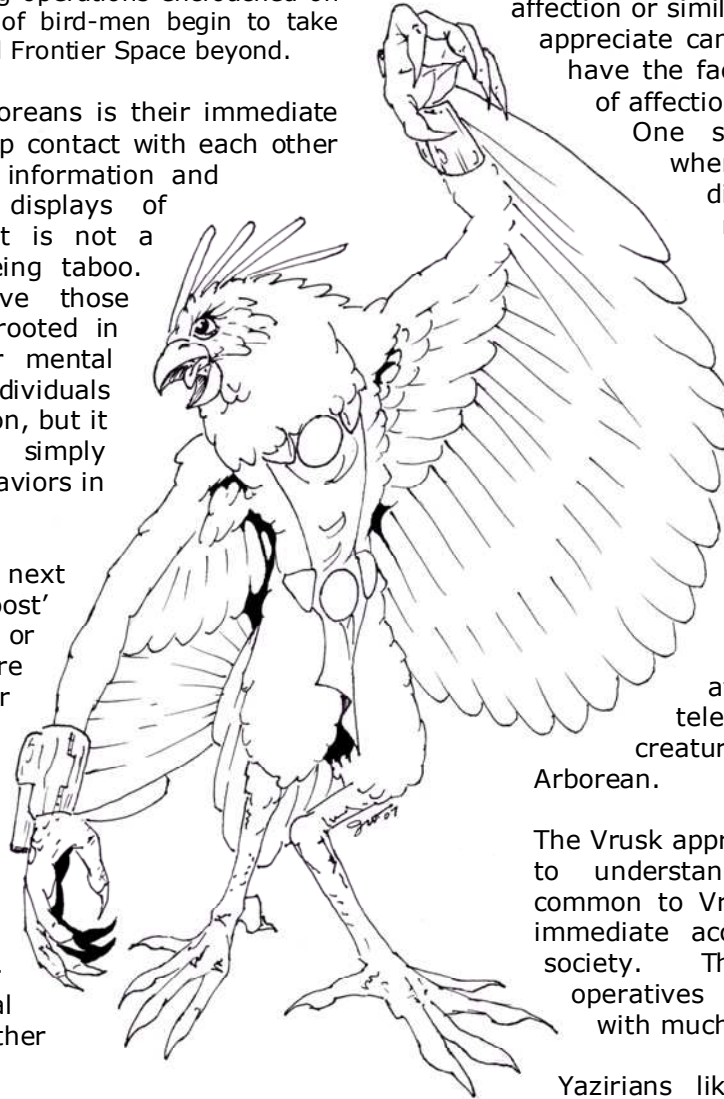

genetically coded remnant of the Eorna manipulations of the Arborean DNA. Regardless of the source, the Arboreans will not cooperate with Sathar, and seem to be immune to Sathar mental influence as well. It is unknown if there are other hidden genetically implanted conditions or behaviors that might be discovered later. The Eorna are quite secretive about the types of experiments that were conducted prior to their contact with the Frontier races.

## SPECIAL ABILITIES

- **Comprehension** (5%) – An Arborean has an uncanny ability to understand situational events. This is quite similar to the Vrusk ability of the same name. All Arborean characters begin with a Comprehension score of 5. This score is the character's percent chance to figure out any sort of social/political dealing that the player himself cannot. For an Arborean, this insight includes tactical maneuvering in addition to the typical social situations.

*For example, an Arborean is following a Human he thinks is a spy for another organization. He follows the Human into a bar and sees him talking to a group of rough looking Yazirians, occasionally glancing over his shoulder. Then the Human hands some credits to the thugs and leaves the bar. The player of the Arborean character is not sure what the Human was trying to do, so he tells the referee that he wants to use his Comprehension ability. If he rolls 05 or less on a d100, the referee will tell him that the individual paid the Yazirians to attack the Arborean if he tried to follow the Human from the bar.*

A character may improve his or her Comprehension score by spending experience points (see Improving Characters, in the Alpha Dawn rules).

In terms of game play, the Comprehension ability works in exactly the same manner as the Vrusk ability gained from keen understanding of complex Vrusk society. It is postulated that this ability comes to an Arborean because of their keen sight and that their minds are accustomed to thinking in three dimensions to facilitate flight maneuvers. These adaptations allow them to view problems from different perspectives simultaneously. The referee should also allow players to ask for Comprehension checks when the player does not understand the tactical maneuvers that his opponents may be using. It is difficult to outmaneuver or otherwise keep an Arborean from understanding what is really going on.

- **Sharp Eyesight** – Arborean eyesight is very keen, even at distances. All range penalties to attack rolls are halved for an Arborean. This does not increase a weapon's effective maximum range, as that is a physics limitation, not a matter of eyesight and coordination. Similarly, the spotting distance of an Arborean is tripled as if they were wearing

magnigoggles. They do not gain any benefit from actually using magnigoggles over this racial benefit.

- **Gliding** – Arboreans can glide short distances by spreading their wing-arms. Assuming no strong updrafts, an Arborean can glide 1 meter for every meter he is above the ground when he starts. He must start at least 10 meters above the ground. The maximum distance an Arborean can glide depends upon the gravity of the planet, as shown below. In their natural mountain habitats there are very strong updrafts that the Arboreans utilize to stay aloft almost indefinitely. In such an environment, the referee should essentially allow the Arborean character to glide about at will (at normal double move rates), but the Arborean must still start from an elevated position.

### ARBOREAN GLIDING TABLE

Gravity	Max. Glide
.6G	150 m
.7G	100 m
.8G	50 m
.9G	25 m
1.0G	10 m

Arboreans cannot glide on planets with gravities below .6 or above 1.

## ARBOREAN CHARACTERS

Characteristics	
Average Size	1.2 meters height (wingspan 2.5 meters)
Average Mass	25kg (densely muscled, light bone structure)
Average Lifespan	120 years
Reproductive System	heterosexual, ovoviviparous
Body Temperature	36 degrees Celsius

Ability Scores	
STR/STA	-10
DEX/RS	+5
INT/LOG	+5
PER/LDR	+0

Movement	
Walking	5 meters per turn on foot
Running	20 meters per turn on foot
Hourly	3 kilometers per hour on foot

Special Abilities	
<b>Comprehension</b>	Keen situation knowledge, 5%. Can be increased by spending experience points.
<b>Sharp Eyesight</b>	ranged adjustment penalties are half normal.
<b>Gliding</b>	Can glide and ride on air currents.

# ABILITY SCORE LIMITS

R. Kevin Smoot

The Alpha Dawn Rules clearly state that characters cannot raise their ability scores beyond a score of 100. This is fine in most campaigns, as typical characters will not reach these heights of advancement. However, there is the occasional circumstance when this top end limit is approached in a high-powered or long enduring campaign.

What is not addressed by this simplistic limitation rule, is why a veteran of a race such as a Yazirian, with their 10 point penalty to STR/STA, can eventually become as strong as a similar veteran Dralasite, with their +5 bonus to STR/STA. It became obvious that the 100-point limit was applied across the board just for the sake of simplicity. Certain races have particular aptitudes or deficiencies, and should keep these aptitudes or deficiencies throughout their career.

The solution is quite simple. The appropriate racial modifiers also modify the upper limit of ability improvement. This means that the Yazirian Veteran mentioned in the example above cannot raise his STR/STA scores above 90. In the case of Humans, the ability score that they boost during character creation is the one score that may be raised to a maximum score of 105.

The following tables summarize both the racial modifiers and the upper limit of improvement. For completeness, the Zebulon's Guide races, old Dragon Magazine (Ares), and races included in previous issues of the Star Frontiersman are included. For other races, such as home-brew creations or from other sources, simply modify the upper limit of advancement by the racial modifiers as appropriate.

The first figure is the adjustment, and the figure in parenthesis is the upper limit of advancement. These figures do not take into account any considerations for equipment or special circumstances (bionics, cybernetics, Gamma Dawn style mutations, permanent disability, etc).

In Star Frontiersman #4, there is an article that further modifies certain races by gender. If that material is used, the upper end stats should be further modified. An old Dragon Magazine (#108) details rules for aging, and if those rules are being used, the limits in the tables above should be considered the limits of experience point based improvement (before any adjustments for age are applied).

Core Races	STR	STA	DEX	RS	INT	LOG	PER	LDR
Dralasite	+5 (105)	+5 (105)	+0 (100)	+0 (100)	-5 (95)	-5 (95)	+0 (100)	+0 (100)
Vrusk	-5 (95)	-5 (95)	+0 (100)	+0 (100)	+5 (105)	+5 (105)	+0 (100)	+0 (100)
Yazirian	-10 (90)	-10 (90)	+5 (105)	+5 (105)	+5 (105)	+5 (105)	+0 (100)	+0 (100)
Human	Add +5 to any single score; that single score has upper limit of 105.							
Sathar	+0 (100)	+0 (100)	-5 (95)	-5 (95)	-5 (95)	-5 (95)	+10 (110)*	+10 (110)*

\* All Sathar must move 10 points from PER to LDR, and LDR must remain 20 points higher than PER.

Zebulon's Guide	STR	STA	DEX	RS	INT	LOG	PER	LDR
Humma	+10 (110)	+10 (110)	+0 (100)	+0 (100)	+0 (100)	+0 (100)	-10 (90)	-10 (90)
Ifshnit	-5 (95)	-5 (95)	+0 (100)	+0 (100)	+5 (105)	+5 (105)	+0 (100)	+0 (100)
Mechanon	+20 (120)	+10 (110)	+10 (110)	+10 (110)	-20 (80)	+10 (110)	-20 (80)	+20 (120)
Osakar	+5 (105)	+5 (105)	+5 (105)	+5 (105)	+0 (100)	+0 (100)	-10 (90)	-10 (90)

Star Frontiersman	STR	STA	DEX	RS	INT	LOG	PER	LDR
Nagana (Issue #1)	-5 (95)	-5 (95)	+5 (105)	+5 (105)	-5 (95)	-5 (95)	+5 (105)	+5 (105)
Bora-Kai (Issue #2)	+10 (110)	+10 (110)	-5 (95)	-5 (95)	-5 (95)	-5 (95)	+0 (100)	+0 (100)
Boon'sheh (Issue #3)	-10 (90)	-10 (90)	+10 (110)	+10 (110)	+0 (100)	+0 (100)	+0 (100)	+0 (100)
Yinni (Issue #4) - basic*	-20 (80)	-20 (80)	+10 (110)	+10 (110)	+5 (105)	+5 (105)	+5 (105)	+5 (105)
Ul-Mor (Issue #5)	-5 (95)	-5 (95)	+5 (105)	+5 (105)	+5 (105)	+5 (105)	-5 (95)	-5 (95)
Vimh (Issue #5)	+0 (100)	+20 (120)	+5 (105)	+5 (105)	+0 (100)	+0 (100)	-10 (90)	-10 (90)
Arborean (Issue #6)	-10 (90)	-10 (90)	+5 (105)	+5 (105)	+5 (105)	+5 (105)	+0 (100)	+0 (100)
Sentient Robot (Issue #6)	+10 (110)	+10 (110)	+5 (105)	+5 (105)	+5 (105)	+5 (105)	-20 (80)	-20 (80)

\* Yinni stats are further modified by caste, not shown here; adjust as necessary.

Dragon Magazine	STR	STA	DEX	RS	INT	LOG	PER	LDR
S'sessu	+0 (100)	+0 (100)	+0 (100)	+0 (100)	+10 (110)	+10 (110)	-10 (90)	-10 (90)
Zethra	-5 (95)	-5 (95)	+5 (105)	+5 (105)	+5 (105)	+5 (105)	-5 (95)	-5 (95)
Saurians	+10 (110)	+10 (110)	-10 (90)	-10 (90)	+0 (100)	+0 (100)	+0 (100)	+0 (100)



# SHADES OF MOTION

C. J. Williams

Imagine invading a system with your massive ships, then they launch their fighters for multiple maneuvers, including bombing enemy ships and even the planet's surface. The fighters

move from hangar to fast-moving space combat to entering atmosphere, carrying on atmospheric dog fights, then strafing anti-aircraft guns, and then conducting drops of soldiers and robots who now do battle on the ground, all the while transferring the scale of proportion, movement, and turn time.

Here you will learn a system for carrying on great adventures that move from one location to another and from one movement speed to another without adversely affecting combat.

This system bridges movement between Alpha Dawn vehicle combat and Knight Hawks Ship combat, and lets the Aerospace Fighters move between them with ease. This doesn't change either system. It just provides them with more shade and makes them flow together seamlessly.

One thing not covered in the STAR FRONTIERS board game mechanics for vehicle and space flight is the third dimension. Previously, all battles have been performed in 2 dimensions without any consideration of the third dimension. This article rectifies this.

## SLIDING SCALE MOVEMENT

Knight Hawks was designed for large space-fairing vessels that are up to 200 times larger than the fighter, and their cruising speed can be expected to be up to 200 times faster.

The size also affects how well these units can maneuver. A fighter could easily slow down and turn and battle within a 10,000 km hex, or even just 100 km. How do you determine exactly where it's going or that it's even moving or not if the piece stays in the same hex? A larger ship, however, isn't likely capable of the same abilities within a 10,000 km hex.

In this system, 10,000 km is the scale for a hex and is used for 10 minute time scale for space units (like Knight Hawks). 2 m is the scale for a hex (previously a square) in 6 second time scale for characters on foot (like in Alpha Dawn). These are the two extremes. One is very, very fast, while the other is very, very slow movement. These cover battle in speeds from 2 kilometers an hour to 600,000 km per hour. When you're traveling at 2-6 kph (walk-run), and reaction speeds are quicker, 6 seconds is more than enough time to take action and conduct battle. At 600,000 km per hour, however, conducting a battle in 6 seconds is nigh on impossible. So 10 minutes ends up



being the best period for ships to maneuver and to aim weapons.

If ships are traveling 6,000 km per hour, however, movement is impossible to demonstrate on 10,000 km hexes and far too fast for 2 m hexes, and 10 minutes is really more time than necessary, as ships moving at this speed can maneuver pretty well and take aim in under two minutes, so 2 minutes ends up being the optimal turn time and 20 km hexes are ideal for movement.

60,000-600,000 kph on 10,000 km hexes with 10 min rounds is the highest end of the scale, which is the standard Knight Hawks movement range. Anything higher and battle is effectively impossible to continue (In fact, battle at this speed is generally unrealistic in itself. Changing scale is the cure. Though this system still allows players to battle at this scale if they so choose), and anything slower cannot be accurately demonstrated on that scale.

Use the Movement Sliding Scale table below to change scale at different times in your game.

## MOVEMENT SLIDING SCALE TABLE

SV	Turn	Hex Size	kph/hex
1	6 sec	2m	1.2
2	6 sec/30 sec	10m/50m	6
3	1 min	1km	60
4	2 min	20km	600
5	5 min	500km	6,000
6	10 min	10,000km	60,000

Example: 6 hexes per turn at SV 4 equals 3,600 kph, and 2 minute turns are best to resolve combat.

**Note:** To adjust your refereeing style and space battle philosophy, consider the average speed of units involved in the battle per what you feel to be realistic, then handle them on the relative hex size and turn time related in the scale chart. If you think over 60,000 kph is too fast for effective battle, then move it down to 6,000 kph per hex traveled.

## CHANGING SCALE ON THE FLY

This system is meant for changing scale on the fly (no pun intended). If you have fighters flying around the ships, or if a battle moves from space to the upper atmosphere of a planet, the units involved will slow down dramatically and continue to slow down until they reach atmospheric velocity (recommended at under 6,000 kph; SV 4). As a result, the scale of both distance and time will need to change. Scale must change depending on distance traveled and reaction times. This sliding scale allows action to continue on a gradual reduction or increase based on the circumstances.

Of course, when you change scale on the fly, graphic maps become irrelevant, so the key is just to stick to one hex map without graphic (unless you're using a board game program on computer with hex scaling that allows you to change hex size in relation to the background graphic).

It is recommended to change scale when action slows to under 1 hex movement or increase to more than 10 hex movement on the current scale and especially when you want to determine what is going on within a single hex.

While movement appears to be dead on the current map, it may still happen on a lower SV. When a ship slows down or speeds up, its acceleration and deceleration must adjust as its mass becomes increasingly harder or easier to control relative to its thrust, and the resultant gees also affect the strain you can put on the ship, its passengers, and its systems. As a result, ADF and MR do not change significantly when changing scale. The exact gradient of momentum change can't be minutely measured without a huge number of calculations, so it is approximated through the change in SV.

When movement slows to 0 hexes on the current SV, but movement is still considered to be occurring, you may change to a lower SV measurement. If a ship is in movement, apply the remainder of its ADF on the new SV

measurement. On that measurement, you are now considered to be moving at 9 hexes (10 - 1 to represent a speed slower than 1 hex on the higher SV; 10 hexes on the current SV equals 1 hex on the higher SV).

Example: Your ship has an ADF of 4. You are traveling at 3 hexes per turn (180,000 kph), and choose to slow down by 3 hexes on the current SV, but want to still move. You are now traveling at 9 hexes of movement on SV 5 (54,000 kph). You have 2 ADF left to spend, and you want to slow down a little more, so you slow to 7 hex movement on SV 5 (42,000kph).

## ADM/MM/VM

In Star Frontiersman #5 I introduced the maneuver modifier (MM) and acceleration/deceleration modifier (ADM), but have decided to drop these in favor of simplicity and because of no clear improvement of accuracy. Considering the near lateral move, the modifiers would only complicate the game. The velocity modifier numbers have also been dropped in favor of a new system explained under the subheading: Combat Modifiers.

## SCALE COMBAT MODIFIERS

When ships conduct combat, conditions of speed and size affect the ship's ability to make an attack, thus affecting the combat modifier. Clearly, it's going to be hard for a large ship to attack a fighter. Knight Hawks completely overlooks this.

**Forward firing** is nearly impossible for KH Size 20 leviathans against small fighters. Thankfully, they usually have turrets and guided weapons. Likewise, a fighter has almost absolute certainty to hit the leviathan. So clearly, forward firing in a fighter has almost no need of an attack roll if you're just trying to attack the ship as a whole. It's quite certainly a given. But the shades in-between need clarifying.

**Size modifier.** If the ship that is being attacked is larger, then add the difference between V Sizes to the modifier (To determine KH ships V Sizes, add 10 to the Hull Size). If it is smaller, then subtract the difference. If the attacking ship is larger and using FF weapons, multiply the difference times 10.

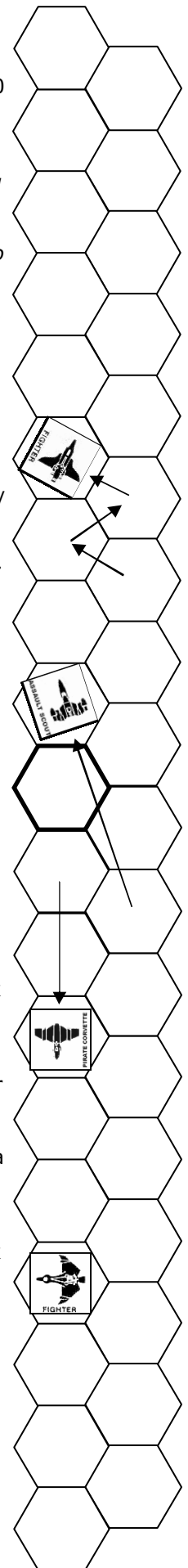

**Velocity Modifier.** If the ship being attacked is traveling on a different direction or one ship is standing still in relation to the other, multiply the number of full hexes the faster ship ends up on its SV away from the slower ship's direction that turn times 10. Subtract the total from your combat modifier.

*Example: A V Size 15 ship (Hull Size 5) traveling on SV 4 makes an attack using turrets on a fighter of V Size 7 that starts out 3 hexes away on SV 5 traveling 2 points (60°) in a different direction at 3 hexes per turn, which puts them 1 hex further away from each other at the end of the turn. So the attacking ship gets a -8 for the size difference, plus -10 for the SV direction difference for a total of -18.*

**Note:** If you consider ship beam cannons to vaporize a broad spread all at once (such as the size of a planet), then ignore these combat modifiers or even all combat modifiers altogether.

## THIRD DIMENSION OF FLIGHT

Triangulation is the best means of tracking an object through a three-dimensional space. Use the following rules to literally give your game a new dimension.

### HEIGHT

When using a hex grid for a planet's surface, the third dimension of atmospheric flight can be simulated by keeping track of a fighter's distance from a stationary point. For now, consider that to be the ground of a planet, or the hull of a large nearby ship (likely the ship from which you launch). Track these as imaginary hexes, as they affect and are affected by your speed and direction in relation to the larger body.

The object you choose as "the ground" will always be on the same plain. Do not think of this as a focal point, but more as a flat surface. For ships as the ground, you can move below the field of the ship, but that ship should always represent a flat plain in relation to the surrounding stars.

You are now freed from the confines of a 2-dimensional map. While your fighter appears to be stationary on one hex, it could be moving at full speed in a perpendicular direction to the map.

**Note:** Height-tracking is the recommended form of tracking for miniatures, though the following double-mapping can still apply if you have a second miniature to represent your ship, though this requires much more table room.

### DOUBLE-MAPPING

Of course, it's easier to track the third dimension when distances are already measured for you. This can be done by tracking movement on a second hex map. This form of triangulation can help facilitate quick movement. However, you don't need to use a large second map, unless you want to. Instead, you can use the vertical track

on the previous page. Use the hex at Point Zero to determine the plane above and below which the action takes place. You do not need to use a ship to identify Point Zero.

In the atmosphere of a planet, consider the bottom hex to be connecting to ground level. If the vessels are too far above ground level, then consider the middle hex to be Point Zero as per normal.

## TRACKING HEXES IN THREE DIMENSIONS

If you move in any direction other than vertical on the vertical track, just move the piece as if on a full map, cycling back and forth between left and right hexes as you move (as demonstrated by the arrows inside the diagram), maintaining the chit's facing. If you need to, demonstrate the movement on the full map and then use the result to determine where it would end up on the vertical track.

Spend ADF/MR with applicable modifiers the same as for two-dimensional movement, except divide it between each movement on both maps (you can move 2 hexes on one map and 1 hex on the other map, representing that you moved 3 hexes), spending all perpendicular movement on the horizontal map and all vertical movement on the vertical track. On the vertical track or map, only count vertical movement and all facing changes.

Now that you're moving in three dimensions, tracking hexes is slightly more complicated, but once you get a hang of it, it will become as normal as moving in two dimensions.

## GROUND COORDINATES

Determining your ship's position in relation to your destination point on a rotating planet as you go from space to atmosphere is pretty much impossible in a tabletop board game, so just assume that your ship and any vessels in pursuit have traveled until reaching your destination point.

If you are actually role-playing, your Referee chooses where you enter the atmosphere from in relation to your destination.

## A NEW ADVENTURE

You are now prepared for a greater board game and roleplaying experience. Nothing will stop you from carrying on games from one environment to another without stop. Seize the opportunity to revitalize your Star Frontiers campaigns.

Incorporating these things into your campaign is both easy and desirable. With it, you can bring new levels of excitement to your campaign.

These rules are easily adaptable to other game systems, so feel free to use them in any space battle game you play.

Good gaming to you.



## NEW EQUIPMENT

Bill Logan

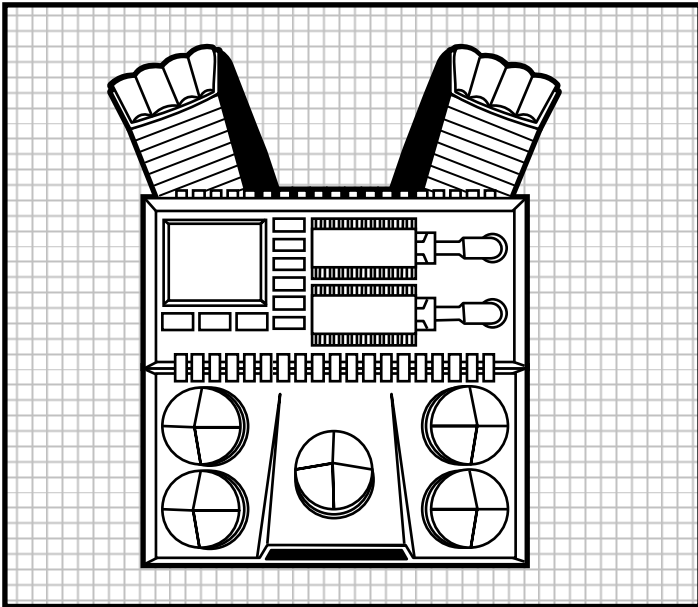

## DISPLACEMENT SCREEN

Scientists from Wartech industries, in a joint effort with Eversafe Enterprises, have worked for six long years in an attempt to create an invisibility screen. Their mission was simple in theory: use technologies unique to both manufacturers in an attempt to bend light in a predetermined path around the wearer of the screen. This proved to be beyond their grasp, though their efforts weren't completely wasted.

The Displacement Screen does bend light, though not always in a predetermined fashion. Light is shifted and bent but only in accordance with the direction of the onlooker. From different points of view, the wearer of the screen will appear to be up to a meter in a different direction. As the onlookers move, the position of the displaced person shifts even more, but in a random direction. It's quite difficult to see exactly where the wearer of a Displacement Screen is, which is exactly the point.

In game terms, the screen drains 1 SEU per turn (from a SEU clip, or can be connected to a power beltclip or backpack) and provides a unique type of protection against any normally-aimed attack (that is, any non-area-effect attacks). Any time the wearer is successfully hit in such an attack, there is a straight 50% chance that the attack actually misses.

*Example: Thravius Chor'th walks confidently into the casino after-hours, his appearance shifting in a dizzying fashion. The goons turn and open fire. Two goons successfully hit with their gyrojet pistols. Thravius's player rolls d100 twice, rolling 44 and 29. The goons were fooled by the shifting image of the displacement screen and Thravius goes unharmed.*

A Displacement screen costs 2,000Cr and weighs 3kg. It is legal to own anywhere other screens are permitted.

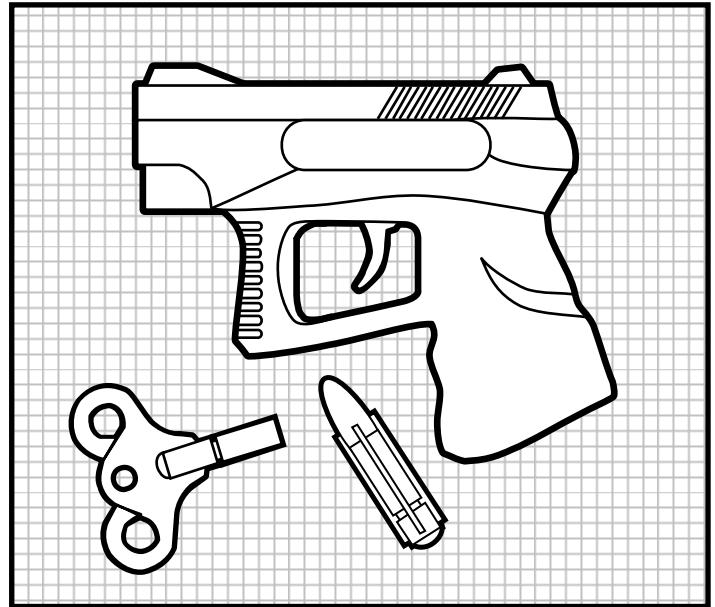

## SECTOR 6 SMALLARM

Agents of the elusive Sector 6 each carry one of these specialized gadgets. They are a type of projectile weapon that uses no explosive part, no combustion, and because of this can be built in an inexpensive resin toy-like gun.

The weapon is tiny – only as thin as the small explosive-equipped single bullet that fits in it. It resembles a small child's toy pistol, and is so thin that it can be kept in the waistband of a pair of conventional pants in a specialized holster that makes most people not see it – even when patting the wearer down for weapons.

The gun itself is wound up like a clockwork device, putting high amount of pressure on a series of cascading coils and springs. Once properly wound up, the gun will maintain its firing potential indefinitely. It takes 3 turns to properly wind and reload the SmallArm.

Only one single bullet fits within the weapon. It's a specialized bullet with an explosive charge inside of it. Built of high strength resin – this bullet does not appear on scans as a type of weapon or grenade.

When the trigger is pressed, the bullet is hurled a fairly short-range. It's not hurled at a supersonic rate so the firing doesn't make any noise greater than a "click-pop." The bullet's explosive shell does 4d10 points of inertia damage but has a very small yield and therefore is not an area-effect attack.

The plastic gun, winding tool, a single resin bullet, and a waistband holster costs 400Cr and weighs a single kilogram, but is often not commercially available except for Sector 6 agents. Replacement bullets cost 25Cr each. The weapon's range is 5/10/20/30/40.

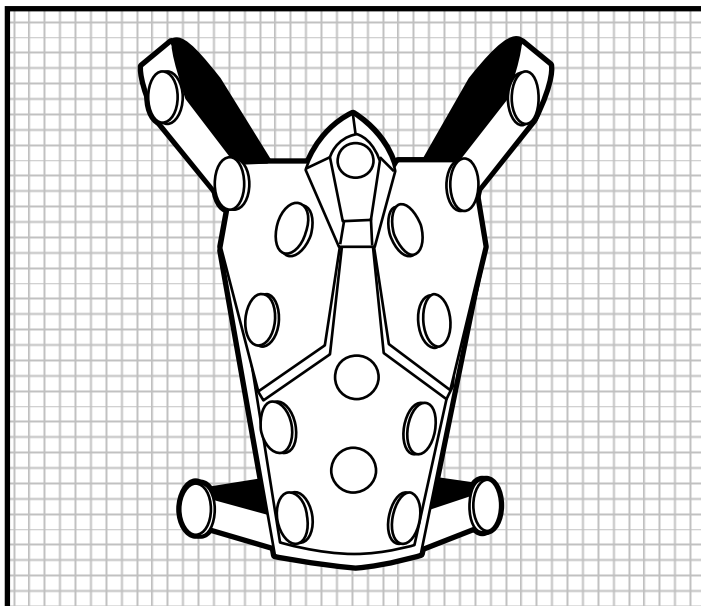

## DETANGLER HARNESS

The tangler grenade is the bane of many adventurers. If caught alone, a tangler can mean the end of your mission – or sometimes your life. Only the prized Solvaway vial can remove the strands, but that relies on having a friend with your best interests in mind.

The Detangler Harness was designed to help the would-be adventurer avoid these pitfalls. It is a harness, able to be worn over conventional protective suits and vests. It can even be worn with screens. It comes with a belt that helps secure it at the bottom, and that belt can be used to hold holsters and other devices and pouches, if desired.

Into the center of the top of the harness is poured six doses of Solvaway. The special liquid is kept there in a reservoir ready for deployment.

The harness itself is covered with a network of special disk-shaped sensors designed to detect the proximity of tangler strands in their hardening state. When the wearer of the Detangler Harness is captured by a tangler grenade's effects, the harness electronics begin a short timer (giving the strands time to harden, as the Solvaway will only work on the strands once in their hardened state).

In the turn directly following being tangled, the sensor disks release the full reservoir of Solvaway liquid in an aerosol-like fashion. It has a 75% chance to successfully dissolve the character's bonds, releasing him in the next turn.

*Example: Jorl is entangled by a security robot's hurled grenade. The turn following the entanglement, a cloud of air-propelled Solvaway fills his immediate area. The next turn, Jorl's player rolls d100. If he rolls less than or equal to 75, he's free and may act normally.*

The Detangler Harness costs 500Cr, yet is not available in conventional weapons shops (since law enforcement often use tangler grenades to pacify aggressors). It is not illegal to own, however. It weighs 3kg. Six doses of Solvaway costs 60Cr. Using less than 6 doses will have no effect.

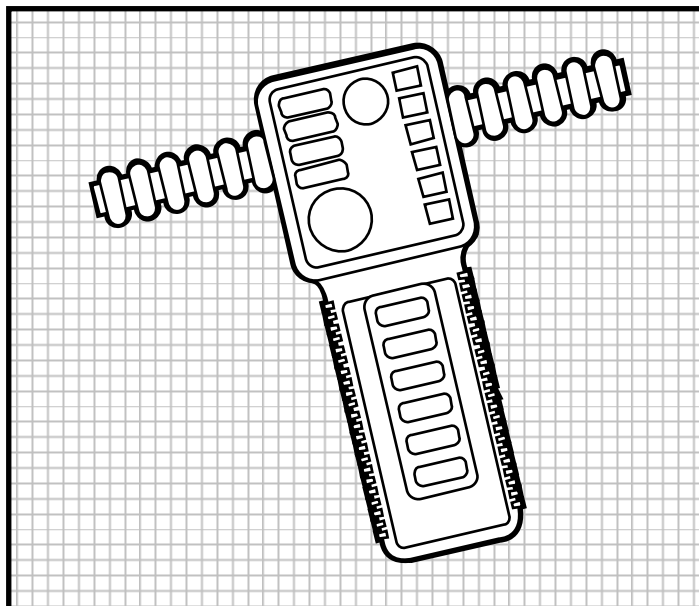

## HOLO-FIELD SCRAMBLER

Holograms are an important part of the Frontier. Holo screens allow people to masquerade as others, projectors to help hide military equipment and vehicles, even video games use holographic projection technology.

But for security specialists, holograms are a real issue. Unless you're trained to look for clues as to their existence, it's pretty easy to fail to notice something concealed in such a manner. Such security specialists often carry a Holo-field Scrambler.

A holo-field scrambler is a hand-held device that emits a special, single pulse of energy designed to interfere with the proper formation of holographic images. It scrambles photon alignment and interferes with the manner in which photons project and reflect off of one another. The end result is a brief but visible scrambling of holographic images.

The holo-field scrambler has a slot for a standard 20-SEU powerclip. It drains 2 SEU each time it emits a scrambler pulse. A security specialist can use the device to program different frequencies of pulse emission in order to interfere with holograms in different spectrums (normally, it only interferes with the visual spectrum, but Infra-red and ultra-violet levels can be scrambled with proper use of the device).

The pulse emission antennae wear over time, and after a few dozen uses they must be replaced. They remove easily by unscrewing them and screwing in the new ones. Replacement antennae cost 25Cr. The Holo-Field Scrambler comes with a single pair.

The Holo-Field Scrambler costs 1,500Cr and is available by mail order or in military/security surplus shops. It weighs 1kg. Package and care is important, as the antennae are quite fragile. A special belt carrying case costs 25Cr and is made of durable canvas.

## GRUNA-GARU SYSTEM

Scott "Danger" Nelson

## HISTORY

Yazirians from Pavor discovered Gruna Garu in their burgeoning explorations beyond their own world early on, but the system itself was left relatively untapped save for small, wildcat mining operations that worked under the aegis of the government.

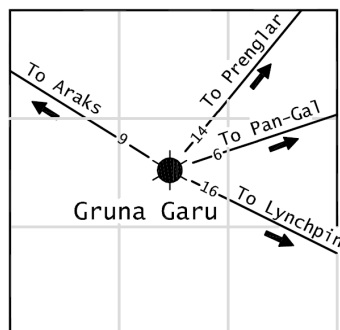

After the Yazirians relocated to Hentz from Pavor, and more and more planets (and other species) were discovered, the Hierarchy began to enact a scheme that originated with the High Priest Noal. This scheme involved the creation of buffer systems around what was now considered the "home" system of the Yazirians. While the general plan was agreed upon by the Church Elders, the specifics were left for future High Priests and their Elders to work out, but the intent was to be able to finally have a planet all to the Church's own. The "others," as the Hierarchy referred to the non-believers or those the Church thought they could do without, were to be allotted planets close by, but far enough away to shield them from the "unsavory," and "unclean" alien species which were found to be populating the same stretch of the universe as they were.

Athor was populated by exiles; of all of the systems which had been found, this one suited the "malcontents," the best. Scree Fron was sold to the merchants and lastly, Gruna Garu was given to the warrior clans which had served the Church so well through the years. Of all the groups, the warriors were the ones most regrettably released from direct control by the Church, but it was felt that they (the Church) could generate an equally effective fighting group from within their own ranks.

So, in and around 68 PF, colonization and expansion of existing infrastructure on Hargut began in earnest by the newly arrived clans. The set-up time for the new colony (to include creation of viable star ports, agricultural self-dependence, and other such things) was expected to take at least three decades by Hierarchy estimates. The Harguttans, as they were referred to now, aided by their counterparts on Hakosoar and others only took around two decades to get the ball rolling.

And roll it did.

One of the initial exports that Hargut had, besides the ores and minerals pulled out of the ground, were the people themselves. Numerous Yazirians from all of the warrior clans who had relocated to Hargut found their livelihood by becoming security forces for Pan-Gal and its subsidiaries. Others wound up as part of space-borne security forces patrolling the wild-n-wooly space lanes in the Frontier. It was also not uncommon for merchants from Hakosoar to hire out Yazirians from Hargut for their own security purposes.

The first Common Muster found quite a few Yazirians from Hargut, but the one event which cemented Hargut's reputation for solid, dependable soldiers was the First Sathar

War. Yazirians, along with Humans, provided the bulk of fighters against the dreaded worms in ground combat situations during this time and it is not an accident that a mixed Yazirian/Human unit (the Amum Rifles which was a highly respected and feared mercenary unit out of Prenglar whose Yazirian contingent hailed from Hargut) gained immortal fame by engaging Sathar ground forces that were twice the Rifle's numbers, beating them, and then keeping Sathar troops involved with running guerilla battles until the Sathar were defeated on what is now Morgaine's World. This group was absorbed into the UPF at its creation and have served as the honor guard for the UPF President and Council of Worlds ever since.

And this is just one example with Yazirians from Hargut.

## THE PEOPLE

(An excerpt from a sales program by WarTech Inc. representatives during the 35<sup>th</sup> Annual Frontier Arms Expo held near Heston at the Whaley Fields proving grounds)

*"...if you look to your left, you'll see our new Fenris model Armored Personnel Carrier which is multi-role capable via the modular armament package which can be easily swapped out depending upon mission parameters in around 30 minutes by any trained personnel. Speaking of armament packages, we are able to provide the customer with everything from simple pintle mounted machine-guns to complex surface-to-air missile batteries. Whatever the mission, WarTech has the answer. Now, on your right, you'll notice one of our people in our Vanguard Mk. 4 personal armor..."*

If anyplace in the Frontier typifies the Yazirian love of competition, it's the system of Gruna Garu.

Colonized primarily by the traditional warrior clans, the planet of Hargut offered an unprecedented chance for these groups to do something unique and something of their own. Before this, they had generally been at the beck and call of the religious aristocracy on Waloo and then Hentz.

Historically, the Warriors from Pavor fought. Nothing more, nothing less. Their whole existence revolved around the act (or implied act) of violence.

The impact of civilization, of modernity and technology began to make their (the warrior clans) more and more irrelevant in the scheme of things. For example, Workers could make missiles which flew by remote command from someone to strike a target hundreds of kilometers away. An "Agoa" (the slang in the warrior clans for someone who would dare to pick up arms and act like a Warrior) could be as effective as a Warrior thanks to all manner of advanced weaponry. By the time of the beginning of the Yazirian exploration of space, the warrior clans still produced soldiers and other such similar individuals, but these clans had been eclipsed by most of the other types of "vocational" clans operating in the traditional Yazirian way.

## NOTABLE PERSONAGES

This fact had a profound impact on the psyche of the warrior clans for a number of years; it is a testament to their personal code of honor that more of the warrior clans didn't explode into violence than what did prior to the expansion into space. But, as any elder Chief in any of the warrior clans will be quick to point out, the colonization of distant stars reinvigorated the warrior clans into regaining the prominence that they once had and for that, they are indeed thankful. When the call went out for explorers to seek out these far horizons, the warrior clans applied en masse<sup>1</sup>.

This whole concept of challenge is one of the key motivators for a native of Hargut. That is why, on average, there are any number of contests, sports events, or political races taking place on Hargut at nearly any time.

This love for challenge (or "Iywoao hkyeer" as its termed in their native language) is also a factor in the high number of beings with betting addictions on Hargut, but that is a subject better covered in a psychology text.

The continuous competition that a native Harguttan endures has had an interesting impact on the honor duel. Rather than Yazirians dueling constantly in the streets of Heston (as some of the more unenlightened media people have been reported as saying) over any slight, the duel has been elevated to a more refined and deliberate act. This has, in effect, created a legally recognized duel that all must honor and protocol must be followed to a "T" when instigating a duel or the results could be made mute by public opinion<sup>2</sup>. A good example of this is when the chiefs of two neighboring clans got in a duel over land rights, the chief of one clan failed to correctly honor his opponent when citing his petition for duel. This same chief also made a slight slur on his opponent's family at some point in the heat of the duel. Even though this chief won the duel, his honor claim was not recognized and the other, losing chief got the land in question for his clan.

A down-side to iywoao hkyeer is that Harguttans cannot easily turn this competitive drive off, and that has led to any number of misread signals from other species. But, this sort of accident is more commonplace on Hargut than if the Yazirian was on another planet as they are reasonably able to realize that they need to dial their behavior back around strangers.

In matters of fashion, food and the like, Yazirians from Hargut are a solid, if unimaginative, bunch. For real Yazirian haute couture, a visit to Hakosoar is in order.

In summary, when one visits Hargut, be prepared to experience a variety of fast paced and intense activities; these Yazirians do indeed work and play hard. Remember your manners, though, but don't be afraid to stand your ground if you feel you are in the right.

<sup>1</sup> All of the systems discovered and which are considered to be "Yazirian owned," were all found by ships commanded by a captain from a warrior clan. The exploration and mapping of the Lesser Morass and Yreva Nebula is also due to a large part to warrior clan participation.

<sup>2</sup> By public opinion, we are talking about only the public opinion of the clans on Hargut. A Yazirian from Scree Fron, for example, can say all they like about an outcome of a duel. Their opinion matters not as they are considered to be ignorant of the protocols.

- **Momma Ciss** – The often-mentioned-but-never-seen "Matron of Little Vela," Momma Ciss is the glue which binds all of those former refugees together in their current community in Little Vela. Keeping the headstrong members of her extended family (which is how she views her community) in check against the continuing advances of the Yazirian nationals is wearing hard against the precepts which Momma Ciss was raised. But, she also knows that given enough provocation, she'll be more than happy to turn her people out against those "arrogant monkeys," any day of the week. She just doesn't know what the outcome of such an even would be, so she cautions her lieutenants to keep it quiet for now.

- **"Red"** – An old Yazirian who looks to have survived more than a dozen or two dozen honor duels on Hargut itself (his "wing" membranes are tattered, torn and completely useless thanks to all of the puncture wounds, slices and nicks he got while in the dueling circle), Red is a walking, talking encyclopedia of knowledge when it comes to one on one combat with an edged weapon. But, as is the case with such successful duelers who've lived past their prime, Red has a tremendous problem with alcohol and the psychological scars of his numerous combats. Red can be found drifting about the Heston star ports getting odd jobs here and there or he can be found in and around Heston at all manner of seedy dives on the South end of town. Red knows himself that something isn't right with him, but is seeking the Warrior's Way home by his own terms.

- **Captain Ben Ellis** – Human Captain of Gamma Company, 2<sup>nd</sup> Battalion, 8<sup>th</sup> Regiment of SpaceFleet Marines which is currently attached to the UPF forces that are established in the Hargut System. Captain Ellis is a highly decorated officer from the Second Sathar War. Captain Ellis is also an embedded Sathar mole in the UPF war machine that has had the luck to be stationed near the planet which houses the primary arms maker for the UPF. Captain Ellis currently has his (unconscious) motive to find out about the new weapons and such in check, but his desire to get down to Hargut and specifically be posted on the guard detail at either WarTech or Whaley Fields is starting to raise some flags in Cpt. Ellis' command. Despite his record, if Cpt. Ellis can't bring himself under control, a psych evaluation is in his future. [Note: Cpt. Ellis is a victim of deep Sathar programming thanks to a situation during the war and he doesn't know a damn thing about it. However, if pushed hard, deep programmed agents may opt out of questioning either by suicide or by attacking their persecutors depending upon the circumstances.]

- **Lance "Gunner" Todd** – CEO of WarTech Inc. "Gunner," as he is known to most everyone on Hargut, is a human who has made G-G the home system / base for WarTech Inc. When asked why he did that, Gunner replied, "As a soldier in the UPF, I had the distinct honor to serve with several Yazirian heavy units. Their drive, their stubbornness, and their love to fight made me enjoy their company. I thought it was only natural to place my business on a world and in a culture which held warriors in such high esteem." "Gunner" Todd is also rumored to have gained the respect of several warrior clans by participating in more than one honor duel; a feat in which humans are not really expected to partake. "Gunner" Todd takes great pride in his working relationship with the Yazirian populace on Hargut and is almost constantly in the news doing something for charity, donating to schools, or promoting goodwill amongst his adopted home. "Gunner" Todd has

four children (three boys and one girl) all of whom are expected to be taking greater and greater roles in the company as they progress in age.

- Priest Aenzur** – The highest ranking Hierarchy official on Hargut, it falls on Priest Aenzur’s shoulders to try and maintain the traditional Yazirian religion amongst the “noble Warrior clans of the most honorable race.” His services in Heston are always fairly well attended, and his message seems to be well received by the masses. On the surface, Priest Aenzur leads a nice, quiet existence, but along with his regular duties, Priest Aenzur also reports directly back to the Hierarchy about the events on Hargut; he also does his best to influence politics in order to try and maintain a Hentz-friendly majority in office and to weed out any of those he deems dangerous to the Hierarchy’s plans. With his public persona to worry about, Priest Aenzur does not sully his hands with any direct activities in the cesspool of political office, but he works through numerous middlemen. Also, a cadre of church “special agents,” works at the behest of Priest Aenzur and it is commonly these Yazirians who keep the middlemen honest and tie up loose ends if and when they occur. Priest Aenzur is a kindly, wise looking old Yazirian who is almost always smiling politely and acting every inch the benevolent, elder church official.

## PLACES OF INTEREST

- Whaley Fields** – The testing area for WarTech’s many and various arms and armor, the Fields are under a Red Flag (Range Control’s traditional way to visibly signal that a range is “hot” and that care should be taken in the area) all day, every day. Considering what WarTech produces, the Fields are enormous; easily taking up several million acres in size. There are innumerable weapons ranges at the Fields, but they are grouped in a color scheme naming convention (R.O.Y.G.B.I.V.; surely we all know this one, eh?) which denotes the general level of weapons which can be safely used there. For example, Red Range 1 is an indoor pistol range near the main parking area at the Fields while Violet Range 53 is the main testing area for various air-to-ground weaponry. Also, a number of these ranges are equipped to simulate real-world conditions, so pop-up targets, moving targets, city-scapes, and all manner of things in between can be found at the Fields. Security in and around the Fields is severe and prone to be very aggressive against intruders. The UPF also has a vested interest in WarTech’s products and it is no coincidence that an (heavily) armed UPF space station hangs in orbit around the planet and that LandFleet troopers can often be found running exercises at the Fields with some of the weaponry and vehicles being developed there. In a related note, the Fields are open to the public on a weekly basis (during the third quarter of the Frontier Year when conditions permit) to watch the astounding live fire exercise held at Violet Range 1. Beings can see all manner of weaponry and vehicles in action, and sometimes even participate themselves in the activities!
- Little Vela** – A charming, quaint section of Klaktow where a great number of refugees from Laco/Dixon’s Star settled down and brought their culture with them in the wake of the first Sathar War. The cuisine, the music, the whole atmosphere of Little Vela revolves around this wonderfully dynamic group and the natives of Klaktow have taken to them wholeheartedly; but some of the more vocal right-wing groups have voiced an increasing amount of concern over what they consider to be “erosion of core Yazirian Warrior values,” and the like by the populace of Little Vela. So far, there has been nothing more but tough talk by the

## Gruna Garu

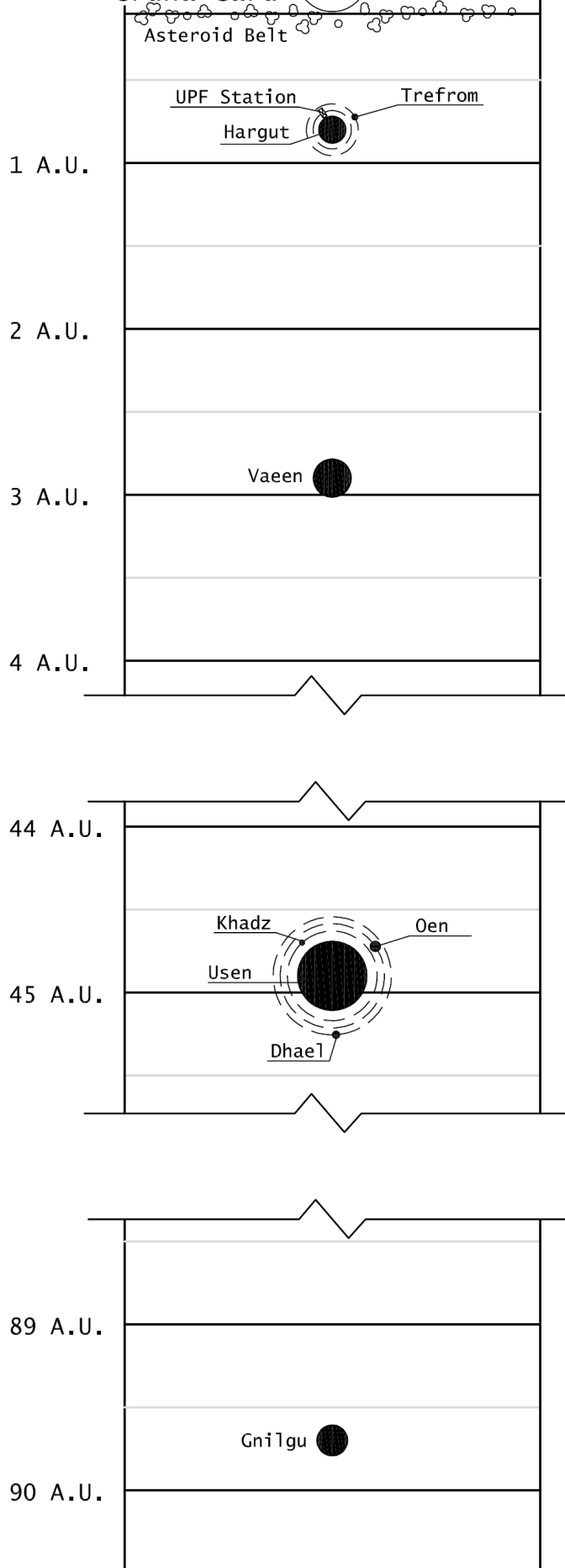



hot-headed on both sides of the issue, but a growing tension can be felt boiling behind the ferrocrete and windows of the shops and homes in Little Vela. One of the outstanding historical aspects about Little Vela is the role the citizens of this area took when the Blue Plague hit Hargut in 22 FY; without fail, each and every one of the "adopted sons and daughters" of Little Vela fell to the tasks of helping Klaktow along in any way that they could while the Plague swept through the streets. To this day, the price these immigrants paid (in loss of life, in time, etc.) while helping their adopted home is a tremendous source of pride for this group.

- The Tulleo Mines** – Found on Trefrom, the mines serve as both an expedient way to provide materials for the growing colonies on the moon itself, and a way for the more rugged individuals to eke out a living. And, as the mines themselves wind their way deeper and deeper into the planet, old tunnels are shored up, refurbished, and developed into living areas for the colonists coming in. The main bulk of the mines are beneath the city of Perim which is also the de-facto capital of Trefrom. These same mines (the ones which are active) are owned by Cascal Mining Corporation (CMC) which is a subsidiary of Association of Intergalactic Power Suppliers. CMC is known for their "business takes all" approach which has left more than a bitter taste in some beings' mouths. Mines are, by nature, dangerous places. Mining operations on an airless moon triple the danger level right off the bat and the Tulleo Mines are no exception to this rule. Numerous accidents have occurred over the years that the Mines have been in operation; the most horrific event claiming seventy-three souls in what has been dubbed the "South Barracks Fire," by historians and the like. Since the fire, there have been several sightings of apparitions and odd occurrences in the area of the mines in which the disaster took place. While dismissed as mere fantasy by most people and the CMC, there are quite a number of old miners who will insist that they've seen, heard, and experienced some strange things in that area too.
- Breyton's** – Breyton's is one of the more popular establishments for the up and coming "Extreme Sport" enthusiasts on Hargut. Flit Board racing, Floater Disk riding (or "Disking" as it's called amongst its protagonists) and Sub Orbital Freefall are the current hot topics amongst the thrill seekers there. Being a hang-out for brash young beings full of their abilities, it isn't too long before a group piles out the door intent on settling an argument in some spectacular way each and every night. Management of Breyton's doesn't try too hard to discourage this (as it adds a bit of "edge" to the place), and impromptu betting can run wild during these events; hefty bribes to Heston law enforcement authorities keeps these sometimes deadly occurrences from bringing too much heat down on an otherwise lucrative establishment. Seen in the seminal trivid "Loosin' It!" and a staple of more than one expose on thrill seeking sports and "out-of-control" places programs found on any number of channels on the networks throughout the Frontier, Breyton's is the model that all other similar establishments seek to pattern themselves by. While flattering, this has had the effect of diminishing the impact of the "Breyton" name and "Breyton" experience and current management is looking hard at a few ways they can recapture the imagination of an audience which is showing signs of looking for the next great thing and the next great place to celebrate it at.

## SYSTEM DETAILS

Star Type .....G8 V Yellow Main Sequence  
 Radius .....6.45 x 10<sup>5</sup> km  
 Mass .....1.31 x 10<sup>30</sup> kg  
 Temperature..... 5,600 K  
 Luminosity..... 6.10 x 10<sup>26</sup> W

## GRUNA-GARU I (Hargut)

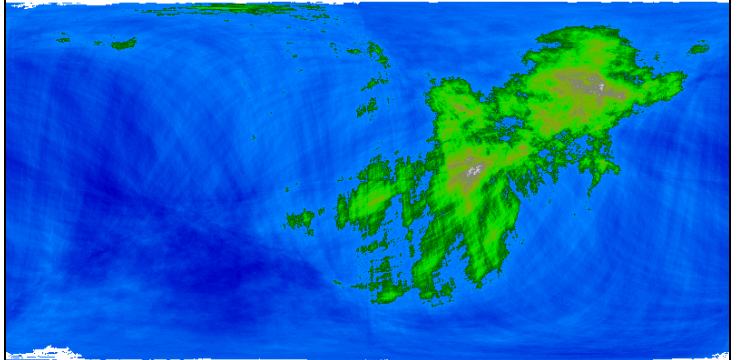

Type	Terrestrial
Orbital Radius	1.26E+08 km (0.82 AU)
Year	349.16 Standard days
Gravity	1.10
<b>Habitable World Data:</b>	
Day	19.5 hours
Hydrosphere	81.7% (2.3% ice)
Atmosphere	Breathable
Climate	-8.7°C to 32.4°C, Avg. 12.4°C
Trade	Various. Also is home to numerous mining operations.
Native Life	No sentient life found. Native life has been reduced to the larger species being protected in various preserves around the planet. Smaller, less dangerous species common around planet. Introduced species have taken over and reduced native species in all of the settled areas and are looking to crowd the native species out of existence in around 20-30 standard years.
Government	Democracy where voting rights based on physical ability. Local elected officials report to regional caucus. Regional caucus determines national officials
Population	High density, 92% Yazirian
<b>Notes:</b>	
Has UPF Space Station "Stalwart" in orbit around it. Station is armed.	

## GRUNA-GARU Ia (Trefrom)

Type..... Rock; Tidally locked  
 Orbital Radius ..... 1.2E+08 km (0.82 AU)  
 Year ..... 349.16 Standard days  
 Gravity ..... 0.25 Gees

**Notes** - The only moon of Hargut. It is housing an increasing number of Yazirians escaping the higher gravity of their mother planet. Currently, the main population centers are Perim and Hul. Both have small capacity star ports available for use.

## GRUNA-GARU II (Vaeen)

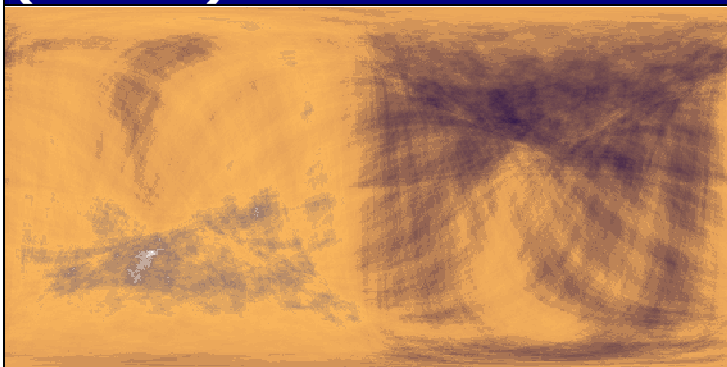

Type	Rock; Resonant spin locked
Orbital Radius	4.4E+08 km (2.94 AU)
Year	2,361.55 Standard days
Gravity	0.25
Notes	Site of a crashed pirate ship <i>Kuttor</i> .

## GRUNA-GARU III (Usen)

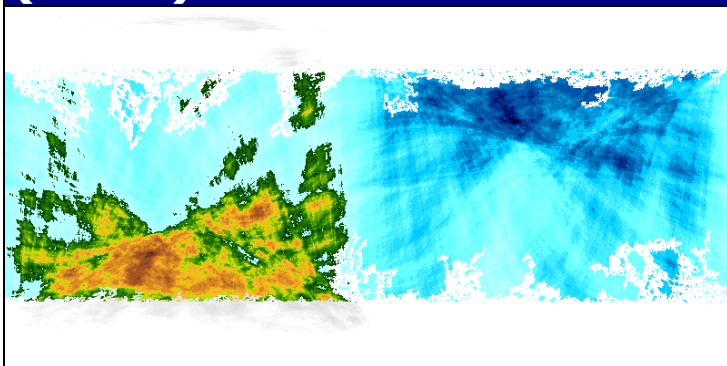

Type	Ice; Low-G, cold, arid, cloudless, unbreathably thin atmosphere
Orbital Radius	6.7E km+09 (44.91 AU)
Year	113,49.94 Standard days
Gravity	0.45
Notes	Unusual methane-ice formations.

## GRUNA-GARU IIIa (Khadz)

Type	Moon; airless rock
Orbital Radius	6.7E+09 km (44.91 AU)
Year	113,491.94 Standard days
Gravity	0.16 Gees

**Notes** – odd fur-like silicon growths on surface.

## GRUNA-GARU IIIb (Oen)

Type	Moon; airless rock
Orbital Radius	6.7E+09 km (44.91 AU)
Year	113,491.94 Standard days
Gravity	0.14 Gees

**Notes** – Old fossils of giant reptiles found here, but no bones.

## GRUNA-GARU IIIc (Dhael)

Type	Moon; airless rock
Orbital Radius	6.7E+09 km (44.91 AU)
Year	113,491.94 Standard days
Gravity	0.14 Gees

**Notes** – Rock formation that resembles a pyramidal structure, not yet explored. Source of conspiracy theories.

## GRUNA-GARU IV (Gnilgu)

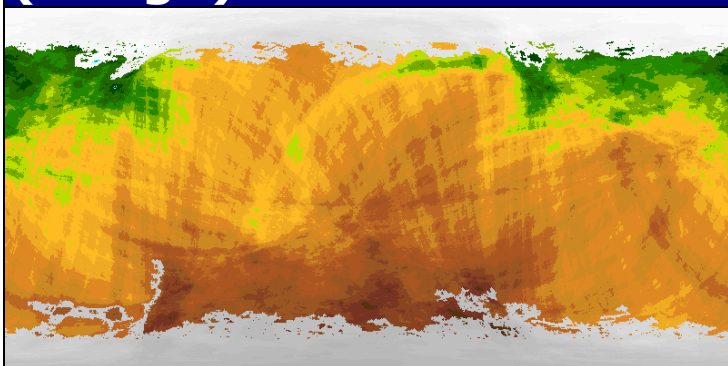

Type	Moons, airless rock
Orbital Radius	1.3E+10 km (89.73 AU)
Year	226,756.44 Standard days
Gravity	0.20
Notes	Nothing of measurable worth found here

## OTHER ITEMS OF NOTE

As befitting its origin as a Warrior Clan colony, soldiers, fighters and those who generally make their living dealing with violence receive a decent bit of respect by Yazirians on Hargut (and to an lesser extent the colonies on Trefrom) almost automatically and despite the species of the creature in question. The flip-side to this trait is that those who are not dealers in violence tend to have to work harder to produce that same amount of goodwill.

This type of attitude has been slowly seeping out of the typical Hargut Yazirian conscious and behavior the longer this group is exposed to the wide variety of peoples and species that populate the Frontier, but in the more out-of-the-way towns and villages on Hargut, expect a little bit more old-fashioned mentality to dominate.

Thanks to the higher gravity on Hargut, Yazirians from here are afforded a little bit more "muscle" than the average 1g raised Yazirian. But, also thanks to the higher gravity, Yazirians from Hargut can expect to suffer arthritis and other such joint related pains earlier in life. A growing number of older Yazirians who don't want to move from their home system are taking to Trefrom in order to take advantage of the lower gravity there. By lessening the wear and tear on their bodies, these "old apes in the sky," (as the younger crowd on Hargut refer to the émigrés to Trefrom sometimes) have managed to extend their lives by quite a number of years. This, in turn, has fostered a mini economic boon in all manner of things on Trefrom thanks to the newly enervated, but older Yazirian crowd. A savvy business being can find all sorts of opportunity on the moon of Hargut, if they have the right goods. ★

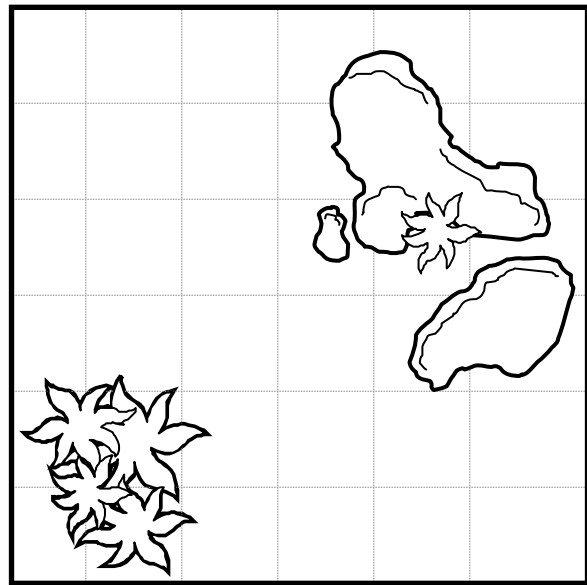
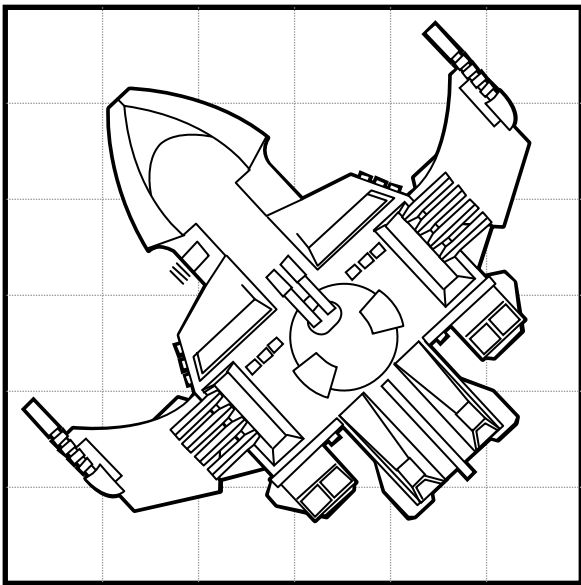
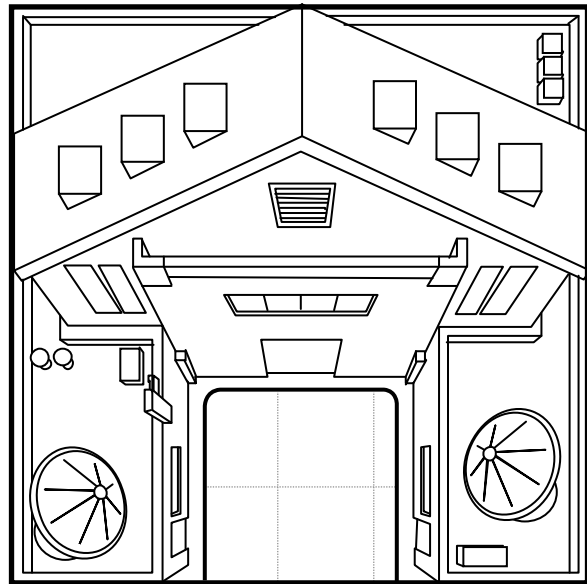
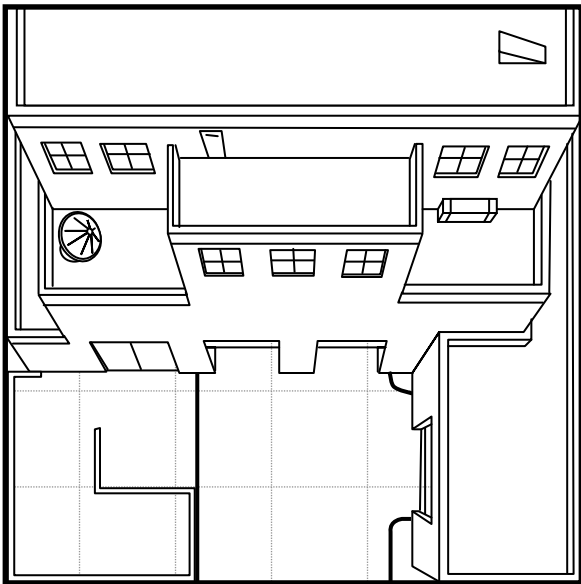
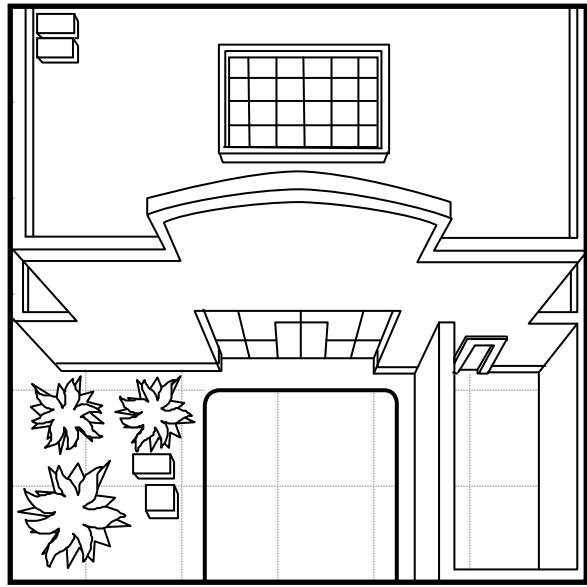
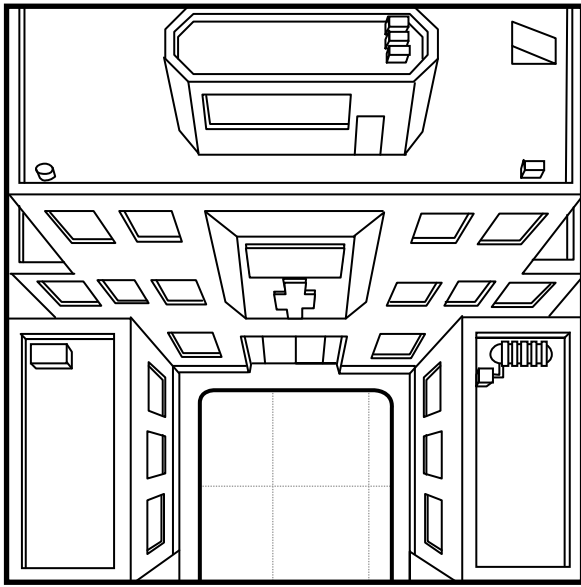

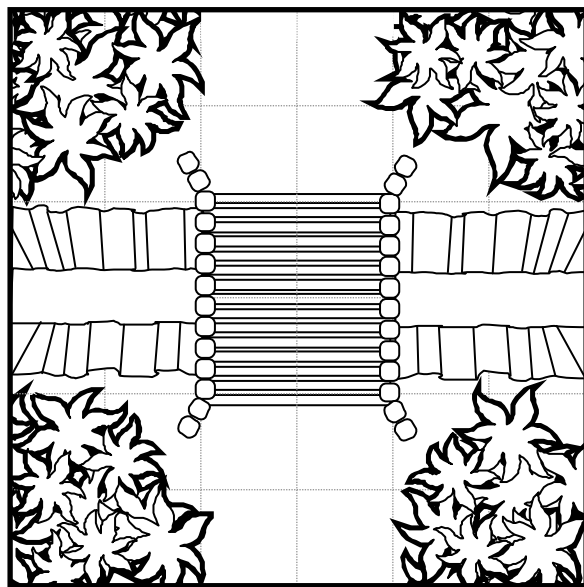
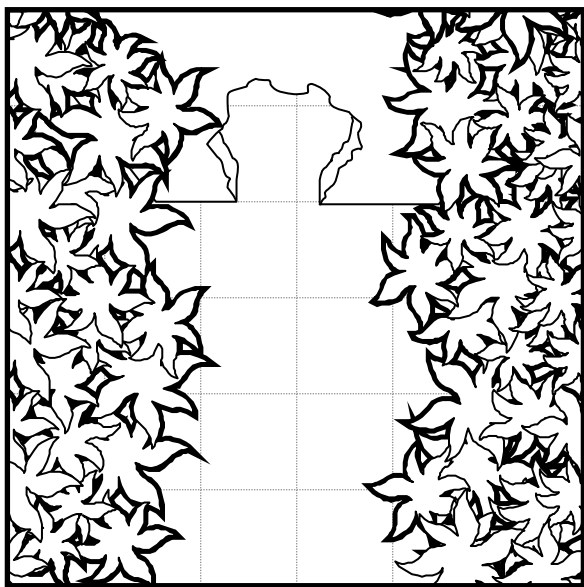
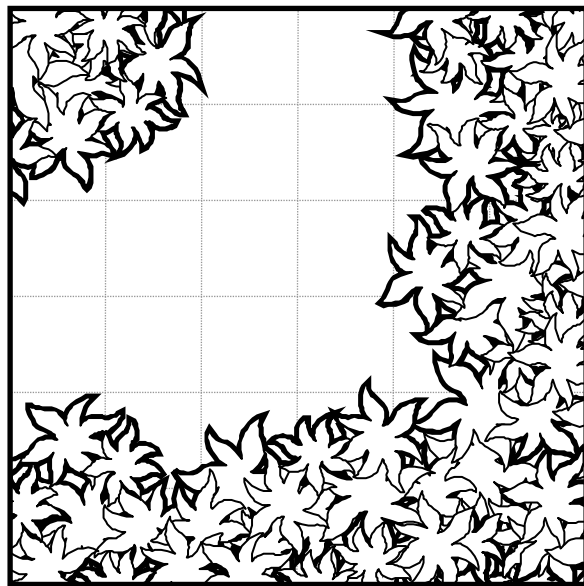
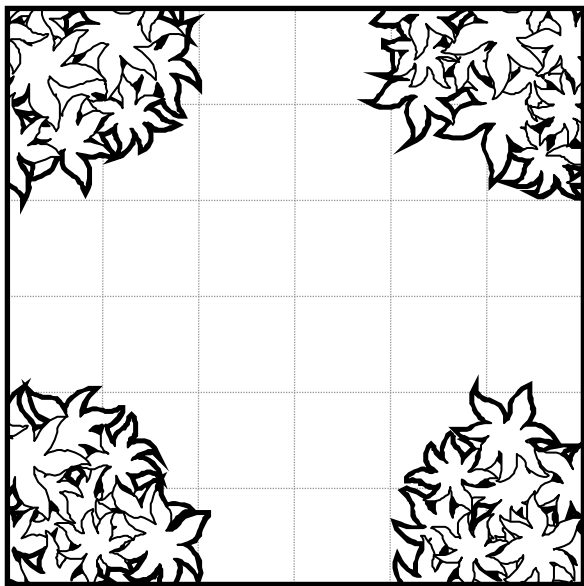
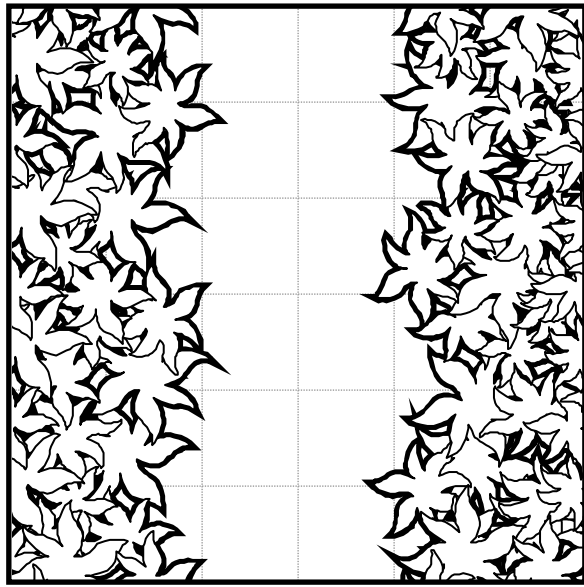
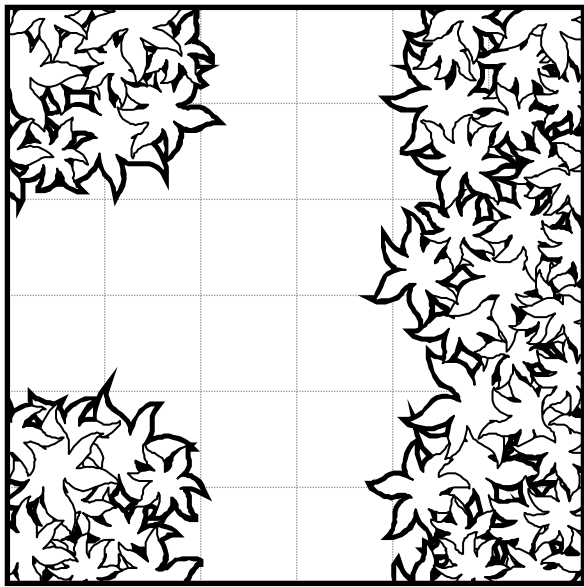

# CIRCLE OF FATE

Auden Reiter

**Editor's Note:** Last issue, I posted a request for prose writers who might be willing to put together a series of articles set in the Frontier... and am very pleased with the offer I received from Auden Reiter. I don't know what sort of background he has in RPG writing, but I know he is listed as a co-author of *Colony Book Two: Life on Utopia, A.K.A. The Waste World: Life on Utopia* (a sourcebook for Heavy Gear, published by Dream Pod 9). His writing feels very Star Frontiers, and I for one am excited to see how this story evolves. At the end of the story, I will provide statistics for the crewmembers, and their fated ship as well. Enjoy the read!

## PROLOGUE

The Dom Majesty shuddered again and her bulkheads groaned under the pull of the nearby star. Failing systems belched intermittent sparks, fires burned uncontrolled, the ship was dying. Lieutenant Nixon floated down one of the corridors in near zero gravity, peering through the acrid smoke, his eyes watering. Years of emergency drills had burned the layout of the heavy cruiser into Nixon's memory. He could find his way from stern to stern, smoke or not, but getting lost was not his concern.

The smoke cleared a little and he could see an intersecting corridor in the flickering lights. He double-checked his position against the bulkhead signage, confirming was right where he should be. He drew his laser pistol from its holster.

"Captain Gideon!" He yelled and pulled himself low. A harsh beam cut through the smoke and played across Nixon's albedo screen. Nixon cursed in pain pushing himself up and back behind the corner.

"You always go low, Lieutenant," Said a voice from beyond the intersection, "That's a gravity reflex. I thought you better."

"We don't have to do this!" Nixon shouted, hoping to cover the scuffing of his feet as he pushed off the ceiling. He frantically searched his memory for a way around the intersection.

"Yes we do, Lieutenant," came the voice, calm despite the surrounding chaos, "this is how I deal with mutineers."

The Captain was probably in the observation lounge just past the intersection. Nixon caught a wall handle with one hand and pulled hard. He shot into the intersection. The Captain's laser found him again, sizzling against the reflective field mere millimeters from Nixon's body. Nixon grimaced. The albedo screen reflected the laser, dissipating most of the energy, but hits still burned deep. The Captain was laying down long fire; the beam would continue as long as he held the trigger. A risky move but it was working. At this rate, Nixon's screen would give out faster than the Captain's SEU pack. And the Captain always carried a spare.

Nixon curled into a ball and flipped over catching another wall handle next to the lounge's kitchen access hatch. He punched his command code and the hatch snapped open with a loud hiss. Nixon moved to enter then stopped himself. He quickly pulled off his screen belt and tossed it into the hatch, then moved to the intersection and peered down the corridor. He could just see the captain moving away from the door to investigate the belt clattering from the kitchen.

Nixon went hand over hand, fast as he could, down the corridor turning at the last second to let his momentum carry him into the room, toward the floor. The Captain turned just as Nixon floated into the room. Their pistols flashed. The Captain's beam hit Nixon in the hand and lashed up his wrist, burning into his flesh. Nixon's shot missed and his pistol

floated away from his ruined hand. Nixon clutched his arm to his chest and tried to keep focus through the searing pain. The Captain just stood there, pistol at the ready. He was wearing a space suit, but the helmet was floating next to him. A white dwarf star, Ceta Prax, shone cool white beyond the lounge windows throwing everything into stark contrast. The star was the whole reason they were there and it would soon devour the ship. Nixon had not missed the terrible poetry of their situation.

"Why," asked Gideon. Nixon was breathing heavy, trying to flex his wounded hand. He stood up slowly from his crouched position, angling his body to hide his left arm as he eased his hand up behind his back.

"I told you why, Captain."

"For them?"

"For all of us! For the ship..." Nixon trailed off.

"You don't sound so sure." Gideon's pistol wavered.

Nixon yanked a gyrojet pistol from under his jacket and pointed it at one of the exterior windows.

"Put the weapon down, Captain," said Nixon evenly, "even if you burn me, I'll get the shot off."

The Captain narrowed his eyes and his aim came back on line. Nixon could feel an itch where the beam would burn through into his forehead.

"You think I would just let you go?" Said the Captain, his voice an icy calm. His finger twitched on the trigger, but Nixon was already moving. Nixon leaped back toward the hallway, firing the gyrojet. There was a soft woosh as a small rocket left barrel of the gun and shot forward under its own power. Compared to the lasers, the rocket moved painfully slow, but the Captain was no fool. He tossed his pistol aside and grabbed his helmet just as the explosive tipped round blew out the window. The atmosphere rushed out of the lounge dragging the Captain into void. Automatic sensors closed the lounge doors with a snap, just centimeters from Nixon's nose.

An ominous creaking sounded from the surrounding walls and the decompression alarm sounded. The ship was coming apart. Nixon was starting to feel the star's gravity. He grabbed a wall handle with his good hand and began pulling himself along the walls in long jerks. The corridors flew by, each with a fading memory of the last four years. All ruined now. All for nothing.

Nixon made his way to the rescue hall, each side lined with empty escape pod hatches. He nearly laughed. All of his bravado was gone, he looked to the ceiling.

"Fine!" he shouted, "I'll go down with the-"

"Nixon!" shouted a voice at the end of the hall, "Move it, junior!"

Nixon crouched to the floor and sprang down the hall clumsily smacking himself into the half open hatch of the ship's only lifeboat. A brunette, female Lieutenant pulled him inside.

"Thanks, Bjan-"

"Tavor's scars, Nixon," said Bjan, "Hurry up!"

Nixon wedged himself into a seat and strapped in. The lifeboat was cramped, only more so with two of the Vrusk crew aboard, their eight legs folded this way and that, awkwardly trying to stay out of the way. Bjan yanked herself into the pilot's chair and slammed the disconnect switches. Nixon barely had time to throw reactive gauze over his arm before the lifeboat jerked then shuddered as Bjan poured on the acceleration. The lifeboat shot into the darkness. Soon the acceleration let up as they reached escape velocity and Bjan eased off the throttle. She looked back at Nixon.

"Did you find the Captain?"

Nixon nodded silently. He turned and stared out of the tinted lifeboat window, watching as the Dom Majesty slowly pinwheeled into the star.

## CHAPTER ONE

Nixon popped his head through the escape hatch of his small freighter and glanced back and forth across the landing pad. The Hope on High was docked at Herson's Bay on Morgaine's World. The dim, early morning light made it difficult to see, but the landing pad appeared empty. Nixon pulled himself through the outside hatch, dropped on to the permacrete, and straightened his clothes. He had taken no more than three steps when a stocky, young Yazirian slammed him against one of the Hope's landing struts. Nixon winced in pain. The Yazirian was a head shorter than Nixon, but half again as wide, with a grip like a magnetic coupler. Another Yazirian stepped into view; this one was female, lithe where her partner was muscled.

"My brother wants to know where you're going, Captain."

Nixon struggled to pull his neck free of the brother's forearm.

"Breh... Breg...," he gasped a few times, finally rasping out: "Breakfast..."

The female chuckled and ran her hand over one of the weighty laser pistols slung low on her hip.

"Oh it's just breakfast? Then why're you sneaking out the emergency hatch? Planning on spending our money on food?"

"Wha... Wuk..." Nixon gasped again. The female tapped her brother on the shoulder.

"Let him speak, Pelot."

Pelot loosened his pin on Nixon's throat, but did not back away. Nixon took a few relieved breaths.

"What money?" he said hoarsely.

"We haven't been paid in three months."

"Yan Ci, I was sure it was only two," said Nixon, immediately regretting his argument. Yan Ci narrowed her eyes.

"Three, Captain, and expenses for the job on Anker."

"Expenses? We never agreed-" Nixon was cut short by Pelot's forearm.

"Fine, fine, expenses it is," Nixon said quickly, "But I can't pay you if I don't make this meeting."

"You have a meeting? For a job?"

"What other kind of meeting would I have?"

"I don't know," said Yan Ci, "do they have meetings for Garvian slugs?"

"If they did, I'd be the first to join," said Nixon lightly, "But since they don't, yes, this is a meeting about a job. A job that I will miss entirely if your... very elegant brother doesn't let me go."

Yan Ci shook her head, exasperated. Pelot glanced at her and she waved her hand.

"Pfa!" scoffed Pelot releasing his grip

Nixon straightened his clothes again.

"Thank you," said Nixon, "now if you don't mind-"

"Three hundred up front or we don't step on that ship again."

Nixon's eyes went wide.

"Three hund-" Pelot growled. Nixon put his hands up.

"Fine. Three hundred. Up front."

"It better happen this time," said Yan Ci.

"It will," said Nixon retreating slowly.

"It better."

Nixon turned away and picked up his pace. Pelot turned to his sister.

"We're never gonna get paid if we don't actually hurt him," he grumbled in Yazirian. Yan Ci shushed him, then narrowed her eyes at the emergency hatch. There should have been a four person escape pod locked to the outside of the ship.

"What happened to the escape pod?!" she shouted across the landing pad.

"Sold it for fuel this morning!" Nixon shouted back without turning then disappeared into the crowd beyond the landing wall. Yan Ci's threw up her hands.

"I can't believe-," she started, then growled, "If he doesn't bring the money, we gut him."

"Finally..." grunted Pelot.

\*\*\*

Nixon walked slowly to the nearest monorail station lost in his own thoughts. He filed in line with the rest of the crowd and tumbled into the nearest train. He quickly grabbed a seat, beating out an elderly woman and her small, yipping reng. The woman glared then moved to the back of the car. Nixon settled in for the ride as the monorail pulled out of the station, rapidly picking up speed.

Herson's Bay flew by the windows. Nixon watched as the dirty, run down city blocks slowly brightened as they flew across the industrial section, through residences and toward the coast. The monorail shot out over water and Nixon could see the tall spires of Herson's Bay city-central on the other side of the bay. He adjusted his clothes again and wished he had spent the credits on a new outfit as his crew had suggested. The monorail made several stops before winding up the central cluster of buildings. Outside several lanes of air traffic, vectored thrust carriers mostly, moved ceaselessly through the sky.

The monorail stopped at the Hurret Building, an angled, smoked-glass megatower with several huge walkways leading to the other buildings in the cluster. Nixon disembarked and made his way to the nearest media terminal for a map. Two human males, too big for the fancy suits they were wearing, blocked his way momentarily, but grunted and moved aside.

Precious minutes later, Nixon found himself in front of Simsome, a restaurant much too expensive for his taste or pocket book. The guards looked him up and down and Nixon flashed a color coded, plastic invitation badge. There was an echo of worry as the guards

looked over the badge, but Nixon reminded himself that the invite was not a counterfeit. He was not used to belonging in a place like this. He had not belonged around the upper class for some time. The guards double-checked the security scanner, making sure Nixon was not armed and waved him in.

An Osakar host welcomed Nixon to Simsom, glanced at his invite badge, and bade him to follow. The host moved with graceful ease across the main floor of the restaurant, so smoothly on his multiple legs, he could have been floating. Nixon was guided to a table with a trio of well dressed humans that rose to greet him.

"Good morning Captain," said the eldest of the trio, "I am Matteredly Wen, this is my associate Doctor Saiya Mave, and our, um... security man, Mikel." Nixon smiled his best smile at the dark skinned goddess of a doctor across the table. She was dressed in a long black dress made of light absorbing voidcloth, leaving her body from neck to wrist nothing but a silhouette. She held her head high as Nixon kissed her hand gently. They all sat.

"Have you been here before, Captain?" asked Doctor Wen. Doctor Mave chuckled into her tea. Nixon straightened up and shifted to his Spacefleet etiquette.

"No, sir I have not," he answered, "but the fair is similar to the Duvrum on Laco. I cannot imagine the morning cakes are as bad though." He winked at Mave, who did not seem to notice.

"Ah, well then," said Wen jovially, "I'll order for all of us. More efficient I think. Also, you won't make the same mistake with the morning cakes."

Nixon smiled genuinely at the man and relaxed a little. Doctor Wen ordered all of them the house special, a huge pile of elegantly arranged meat, breads, and fresh fruits. The table echoed with idle chit chat as Doctor Wen asked Nixon about his work. Nixon was politely vague, but entertained the elder Doctor with a story or two. Doctor Mave was silent throughout the conversation, despite Nixon's attempts to engage her. Once they had finished their first course, Doctor Wen launched right into the work.

"We represent Argos University," he began, "or rather elements thereof."

Nixon nodded. Argos was the second largest university in known space. This expedition would not be publicly sanctioned unless it was successful. Doctor Wen continued in a low voice:

"We believe that there is an alien artifact of great power on Ceta Prax four."

"Ceta Prax?" Nixon interrupted, "That's in the Xygag nebula."

Doctor Wen nodded. Doctor Mave stirred her remaining food with her fork.

"We were lead to believe that you are familiar with the region," she said nonchalantly.

Nixon sat back, narrowed his eyes. They had done their research, that was for sure, and Doctor Mave wanted him to know it. He had not been in the Xygag since his dismissal from Spacefleet. If they knew about the Ceta Prax expedition, they knew about his dismissal. His frown turned to an easy smile. He knew this game.

"I am," said Nixon, "it's a dangerous area of space." He mentally added costs to his fee.

"We know," said Wen, "That's why we wanted someone with professional experience."

Nixon mentally added another percentage as he wiped his mouth and pushed his plate away.

"What kind of artifact?"

"Something very, very old," said Wen. Mave cut him off.

"Something we'd like kept quiet, Captain."

"Fine," said Nixon, "I'll get you out there and back, with a month standard for digging up whatever it is you want... twenty-one thousand."

Mave looked to Doctor Wen who leaned back and massaged his beard.

"Eighteen-thousand, two months, and we supply the food."

Nixon glanced at the empty plates on the table. The old Doctor would provide something better than military rations. He was not happy with the figure, but work was work. Nixon nodded and extended a hand. Wen took it and shook firmly.

"We have an arrangement," said the elder Doctor.

"There is one more thing," said Nixon, "I'll need two thousand up front."

"How crass," said Mave.

"You're asking for crass work, Doctor," said Nixon glaring at her, "I already have expenses to cover."

Doctor Wen frowned. Nixon hated to disappoint the old man, but this was business now.

"We can offer you a thousand," said the elder, "But we leave in six hours." Nixon nodded easily. Wen was no fool, which was a nice change. Nixon handed the old doctor his temporary dock card as he left.

Mikal had remained silent the entire conversation. He had watched Nixon intently and continued to do so as he left. Once Nixon was out of sight, he turned to Doctor Mave and nodded. She frowned and pulled a small communicator from her handbag.

\*\*\*

Nixon pushed his way through the crowd feeling a little light headed. He stopped and flexed his scarred hand. It had been six long years since Ceta Prax. Not long enough. He sighed heavily and looked to the sky. After a moment, a couple of mountain-sized shadows fell over him. Nixon looked up to see two human males, too big for the fancy suits they were wearing. This time they did not move. Nixon regarded them for a moment and regretted not being armed. He smiled and punched the first man square in the nose. There was a loud smack, but the man did not move. A small trickle of blood ran over his lip and his eyes glinted with metal. Nixon cursed:

"Cyborgs..."

He dodged the massive, sweeping arms of his attackers and bolted into the crowd as the two hulking men chased after him. Nixon searched his memory for some past sin that might explain their dogged pursuit, but came up empty. Which meant it was something recent. Something like breakfast. He knew he should have held out for more money. The heavy footfalls behind him told him the two 'borgs were gaining. Nixon took a guess and cut down a narrow passageway. The guess was wrong. The passageway emptied onto an open deck with no other exits, ninety some floors above ground. Nixon screeched to a halt and his shoulders dropped. He tapped his chronometer twice, turned, and put up his hands.

"I suppose a bribe is out of the question?"

The two men approached him slowly, silently, strange machinery twisting under their clothes.





# SECTOR 6

*Bill Logan*

## BACKGROUND

At the close of SWI, there were many military groups disbanded, and we're always hearing about this. Many people wonder if such a disbanding is prudent – wondering if the slugs are going to return more powerful than they ever were. Others think it wise to shrink the military, as budget concerns prevent upkeep of a sizable wartime army except where situations warrant.

But what we don't hear much about are those groups (military and otherwise) that have come into existence at the close of the dreaded Frontier-wide war. These locations are kept secret, concealed from the general populations of the Frontier. They are labs, studying what little remnants of Sathar technology and physiology they can get their hands on. They are think-tanks, theorizing what went wrong and how to prevent it. They are research and development groups, where the most brilliant minds of the Frontier... members of all the dominant races... work together to build better defenses and better offenses. Most corporations know of the existence of these highly classified UPF facilities, but they don't talk about it. The CEOs of these corps know that if the slugs ever do return, the clash of civilizations will be worse than last time, and a stronger UPF will be vital.

But most secretive of all is Sector 6. Originating in the remains of a bombed out mining facility on an undisclosed asteroid (presumably bearing the name "Sector 6"), this agency is the home to some of the most dangerous group of mercenaries, soldiers, spies, techs, scientists, and survivors the Frontier has to offer.

In the entire Frontier, one organization – Sector 6 – stands mightiest between the Sathar and their ultimate goal of galactic subjugation. This agency, comprised of courageous and dedicated professionals, struggles to thwart the schemes and machinations of the Sathar. They do it from the shadows, to keep their identities unknown, and to keep the Sathar from ever learning of their headquarter locations.

The operatives of this organization, few in number, have learned of the existence and nature of the Sathar, and dedicate their lives to combating them. They are a diverse and multitalented group of agents, hailing from nearly every planet and species in the Frontier.

## MISSION

The mission of Sector 6 and its agents is to uncover the activities and operatives of the Sathar, to expose and/or neutralize them, and to prevent the foe's plans from coming to fruition. Since the inception of the agency, most successful operations against the Sathar have had Sector 6's influence.

## ORGANIZATION

Sector 6 is organized into six Cores, each named unimaginatively by a greek letter (Alpha Core, Beta Core, Gamma Core, Delta Core, Epsilon Core, and Zeta Core) and is responsible for a specified Frontier area. Each of the Cores has a secret office, run by a Director. The six Directors meet once each year in a council called Sector Prime. Special meetings of Sector Prime may be called to deal with emergencies.

Individual Cores are each an island unto themselves, based in various locations (some mobile) and acting self-sufficiently. Some coordination is necessary, though, to help keep information flowing from Core to Core. Such operations are controlled from an office known as Core Central. This office rotates every five years from the central office of one Core to the next.

Two special branches exist within Sector 6, and are not tied to any of the individual Cores, based in the original mining facility on the asteroid on which the agency was founded. These can be summoned upon need by any of the Directors, and are commonly used to help agents prepare for or complete an operation.

### THE OMEGA TEAM

**Ω** This group maintains forces on mobile space ships, always at a state of readiness. Each force numbers about three dozen agents trained in commando and anti-terrorist operations, with very high levels of training against mental control and dominance. Agents who need firepower for backup or support can request that their Director call upon an Omega Team.

Field agents are often assigned to train and work with an Omega Team. This involves specialized combat and survival training in a variety of settings. The length of an agent's stint with an Omega Team varies from a single operation to a year.

### THE RESEARCH AND DEVELOPMENT GROUP

**Δ** The R&D Group is the branch of Sector 6 devoted to the development of special devices, unique vehicles, and innovative uses of technologies.

The RD1 group handles all administrative and financial needs for the Research and Development Group; RD2 handles new technologies development and basic research; RD3 is in charge of development and construction; and RD4, the group field agents deal with most frequently, is in charge of distribution and training. Some claim there exists an RD5, which is in charge of acquisition of foreign technologies (read: theft) and RD6 which is in charge of genetic research, but these last two are open to debate.

Top scientists and engineers from many corporations serve stints in Sector 6 R&D Group. The group maintains a steady rotation of personnel, ever seeking new and unique ideas, but ensuring secrecy of the application of their technologies.

## FUNDING

Sector 6 is financed through a series of trust funds established during the agency's first years, and from bounty captured from Sathar spy's coffers during successful operations. In addition, the group receives donations from several corporations, a few of which are indirectly controlled by Sector Prime or its individual Directors.

## SECURITY CLASSIFICATIONS

The following classifications are used to define the security level of all documents and operations.

**CLASS-1:** All indicated information should be publicized by any means possible. News conferences, discreet security leaks, press releases, and interviews should be aggressively pursued in order to gain maximum media coverage. New agents are rated Class-1 until they complete their first mission, meaning they may only handle information that is rated Class-1.

**CLASS-2:** The information is restricted to agents and employees of Sector 6, and their contacts who may find the information of immediate use. The information should be kept out of public hands if possible. Agents are rated Class-2 after successful completion of their first mission. They are then able to handle any mission dealing with Class 1 or Class 2 information.

**CLASS-3:** The information is secret, and will only be furnished on a need-to-know basis. Accidental leaks of Class-3 material will result in an agent's suspension from operations; those individuals unwittingly exposed to the information should be apprehended and held until the information is no longer relevant. Agents are elevated to Class-3 clearance after a full year of Class-2 service, providing they've not met with any punitive measures.

**CLASS-4:** This is top secret information, of the highest security classification. Leakage of Class-4 information is cause for immediate liquidation. Persons unwittingly exposed to Class-4 material must be silenced for the duration of the material's usability. Exact means are left to the agent on the scene. Agents with Class 4 clearance are very few in number.

## OPERATIONS

The following characteristics are shared by agents of Sector 6.

### RECOGNITION SIGN

Sector 6 agents and operatives can indicate their connection by use of a secret recognition sign. This is a subtle hand gesture in combination with a facial movement that is able to be performed by all species of the Frontier. Each year, one of the topics of discussion for Sector Prime is to discuss how the recognition sign will be performed until the next meeting.

### CODE OF CONDUCT

The following tenets should guide the actions of operatives in the field.

1. Never take a life, unless doing so is absolutely necessary for the advancement of the assigned mission.
2. Do not contact the Core, unless failure to do so will result in the failure of the assigned mission.
3. Obey all local laws to the extent possible, without compromising the assigned mission. Do not break a law just because it is an inconvenience.

All proposed operations and actions must be carefully weighed against their expected consequences and against their worst case consequences. The success of the mission must clearly outweigh the expected consequences and must be viewed in proportion to the worst case consequences.

*For example, an action that has an estimated 75% chance of exposing a Sathar operation would clearly not be appropriate if the action would result in the destruction of a major city... another way should be sought or the agent will have to stand before a Sector 6 committee to answer for his or her field decision.*

## EQUIPMENT

The R&D Group provides each agent with two items of special equipment in addition to whatever other equipment may be necessary and available. These devices aid agents in identifying and communicating with one another.

### SECTOR 6 CHRONOCOM

This device looks like a normal chronocom. It can perform the normal functions of a watch, chronocom and calculator (including reporting the time for any of the frontier's local planetary time zones). Its range is double that of a normal chronocom, however (10km instead of 5), and it's able to send a single coded subspace message (though doing so will deplete the internal power source) to get an important message to the Director of the agent's Core. This is usually only done in a single very important moment for the agent, and most agents go their lifetime without ever having to use this feature.

### SECTOR 6 SMALL ARM

This is a special small handgun made of nonmetallic parts, powered by compression and spring coil. It is wound up like a watch, making it difficult to use quickly. It has a slow rate of fire and has limited stopping power. They are normally only helpful in two situations: as a secondary weapon when your primary weapon is depleted or lost, or in a location where other handguns are taken. No known type of automated detection process will detect the S6 Small Arm as a threat. It will be ignored by robots searching the agent. Plus, it's small enough that most people searching the agent will fail to notice it. It is often worn in a tiny specialized holster in the hem of clothes. Exploding shell does 4d10 damage, but has the range of a needler. One shot per load. Uses Projectile Weapons skill to hit, weighs nearly 1kg.

## AGENT COMPENSATION

The base pay of a Sector 6 agent currently stands at 30,000 Credits per year. This applies to employees at all levels of Sector 6, including Directors. However, many agents augment their income through the Sector 6 Bonus Plan.

### BONUS PLAN

The bonus plan allows agents to collect up to 10% of any gains made on a mission as a direct bonus, to be divided among the participating agents in an appropriate fashion. This bonus will not exceed 1,000,000Cr for a single mission, and is awarded at the Director's discretion.

Agents are provided with transportation, equipment, and weaponry deemed necessary for the completion of the mission. Special equipment modifications, strongholds, and special security provisions must all be paid for by the agent themselves. Agents who wish to go to the expense of developing private offices or strongholds will be allowed to base their operations there.



**STR** 55 75 **STA**  
**DEX** 80\* 61\* **RS**  
**INT** 60 50 **LOG**  
**PER** 55 75 **LDR**

\*DEX/RS is really 85/66, see Defenses

**INITIATIVE MODIFIER** + 7  
**PUNCHING SCORE** + 4  
**RANGED WEAPONS** 40 %  
**MELEE WEAPONS** 40 %

CURRENT STAMINA



NAME SARAN WOLFE, OMEGA TEAM COMMANDER  
 RACE HUMAN AGE 32 YRS  
 GENDER FEMALE HEIGHT 1.9 M  
 HANDEDNESS LEFT WEIGHT 70 KG

COMMENTS: "THE ONLY GOOD SLUG IS A DEAD ONE."  
 ONCE A STAR LAW DETECTIVE, AGENT WOLFE TAKES HER JOB SERIOUSLY. SHE'S COLD AND METICULOUS, EARNING HER THE NICKNAME 'BORG'. SHE IS ON RETAINER AT BETA CORE ADMINISTERING SPECIAL TRAINING TO AN INTREPID GROUP OF AGENTS READYING FOR AN IMPORTANT MISSION.

10M/TURN

WALKING

30M/TURN

RUNNING

5K/HR

HOURLY

WEAPON	DAMAGE	To HIT	RANGE	NOTES	AMMO
CUSTOM HEAVY PISTOL	2D10 PER BULLET	100%*	5/15/30/60/150	SEMI-AUTOMATIC, ROF=3, USES A STANDARD BULLETCLIP BUT LONGER BARREL GIVES MORE POWER	20
SEMI-AUTOMATIC PISTOL	1D10 PER BULLET	100%*	5/15/30/60/150	SEMI-AUTOMATIC, ROF=3, USES A STANDARD BULLETCLIP. INEXPENSIVE, EASY TO REPLACE.	20
*NOTE: WHEN USING THESE TWO WEAPONS TOGETHER, SARAN HAS A 90% TO HIT WITH HER HEAVY PISTOL AND AN 80% WITH HER SMALLER ONE.					
SONIC SWORD	5D10 PER HIT	95%	MELEE	DRAINS 2 SEU PER HIT	20

**DEFENSES**

**PARTIAL POLYPLATE ARMOR** 8KG  
 1/2 PROTECTION FROM ALL LASER/BALISTIC,  
 -5 TO DEX/RS (ALREADY SUBTRACTED ABOVE)  
 100 POINTS:

**SKILLS**

PROJECTILE WEAPONS 6 +60 TO HIT  
 GYROJET WEAPONS 4 +40 TO HIT  
 MELEE WEAPONS 4 +40 TO HIT  
 ENVIRONMENTAL 2  
 TECHNICIAN 3  
 COMPUTERS 1

**EQUIPMENT**

WEALTH 2,750 CR

**STANDARD EQUIPMENT PACK** 1KG 6 SPARE BULLETCLIPS   
 CHRONOCOM - CURRENT:   
 UTILITY ONE-PIECE WITH MANY POUCHES -   
 FIRST AID PACK -  
 ID CARD - 2 SPARE SEU POWERCLIPS   
 POCKET FLASHLIGHT - CURRENT:   
 POCKET TOOL -   
 STAYDOSE -  
 STIMDOSE -  
 SUNGOGGLES -  
 RATIONS: 5 DAYS

**SECTOR 6 CHRONOCOM** --  
 10KM CHRONOCOM, BUT CAN SEND 1  
 SUBSPACE MESSAGE (THIS DEPLETES IT)  
**SECTOR 6 SMALL ARM** 1KG  
 WIND-UP ONE-SHOT PISTOL THAT SHOOTS  
 EXPLODING SHELL THAT DOES 4D10 DAMAGE  
 NOT DETECTABLE BY CONVENTIONAL MEANS.

PSA  MILITARY  TECHNOLOGICAL  BIOSOCIAL

TOTAL WEIGHT CARRIED 10KG

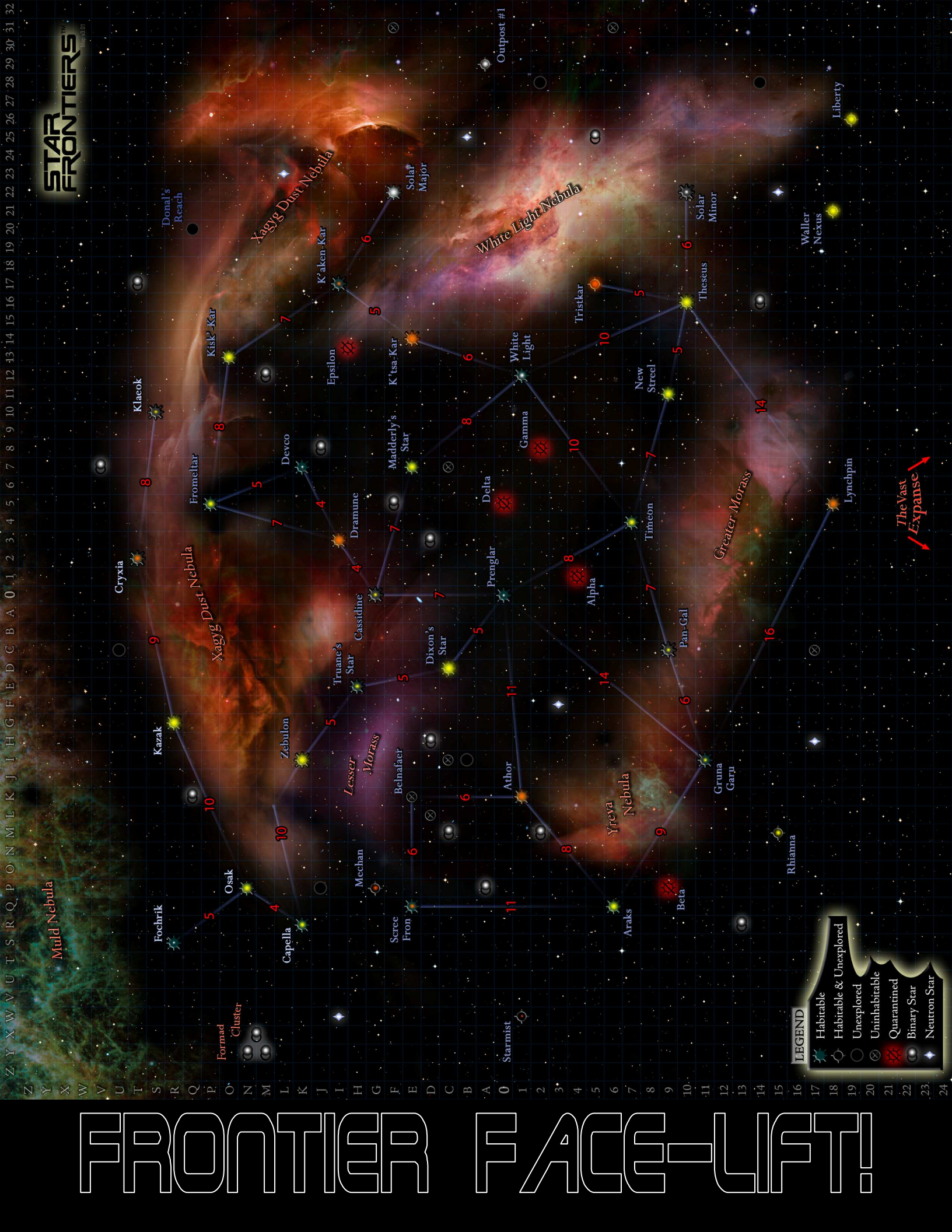

Z  
Y  
X  
W  
V  
U  
T  
S  
R  
Q  
P  
O  
N  
M  
L  
K  
J  
I  
H  
G  
F  
E  
D  
C  
B  
A  
0  
1  
2  
3  
4  
5  
6  
7  
8  
9  
10  
11  
12  
13  
14  
15  
16  
17  
18  
19  
20  
21  
22  
23  
24

**LEGEND**

- Habitable
- Habitable & Unexplored
- Unexplored
- Uninhabitable
- Quarantined
- Binary Star
- Neutron Star

# FRONTIER FACE-LIFT!

The Vast  
Expanse

# A NEW MAP FOR A NEW AGE

*Darrell C.L. Donald*

O' how the light years do go by! It's hard to believe that its really been 22 years since I took one look at Keith Parkingson's gorgeous cover to Zebulon's Guide to Frontier Space, picked up my jaw, emptied my wallet, and sprinted home to consume the new material with an appetite that could only be matched by Pac-Man on crack.

Converting from Alpha Dawn to the new Zeb mechanics could wait. The new content couldn't. There were freaky aliens to get to know, cutting-edge gadgets to put to the test, and fresh star-systems just begging to be explored. The new Frontier map by Dennis Kauth was particularly nice and I remember how eager I was to have my players hitchhiking around the galaxy.

Yet, despite the fantastic content, something must have torn me away from Star Frontiers that summer because I just can't quite remember spending much quality time hanging out with the Humma (or, for that matter, any of the other Rim races.) Perhaps, at age 14, some other more terrestrial life-form started distracting me with their Sathar-like hypnotic charms. Whatever the reason, Star Frontiers faded to black.

Flash-forward a couple decades.

Fade to white.

A man—now at the ripe, old age of 35—finds himself headed to the Aloha state. It's not enough that his childhood gaming friends are already scattered across the mainland, he has to add a couple thousand more miles and the Pacific to the gap.

Back when Zeb's Guide was released this situation would have been the proverbial nail-in-the-coffin for gaming opportunities with old friends—"Sainara, Sundown, we hardly knew ya!" But a new age has dawned and distance just isn't the obstacle it once was. There are people out there in the wilds of cyberspace keeping hope alive. With Star Frontiers, Bill Logan's Star Frontiersman Webzine is leading the charge for an exciting revival. And, in table-top gaming, there are dozens of great tools breaking ground and bringing together new and old players from across the globe in a way that people only dreamed about twenty years ago. For me, two efforts have stood out most: Rptool's Maptool and Battlegrounds.

While there are a number of impressive virtual table-tops (VTTs) out there worth talking about, exploring them is another article for another time. What these hastily scribbled thoughts are really about is how VTTs inspired me to dig up the Zebulon Frontier Map and give it the ole' bionic work-over. In nut-shell, it was all about giving back to the growing community. It was about churning out some fertilizer.

That's right, folks, I just called the map I spent a good week customizing and slaving over a, "Steaming pile of digital compost."

In the world of VTTs and Star Frontiersman, that's all these contributions really are. When home-grown, grass-roots, projects that are defining the next age-of-innovation start gaining momentum, it's up to the community to feed the beast. It's about hoping one's small contribution gives a little sustenance to the masses starving for something they can sink their teeth into.

This is just one snack in a huge, all-you-can-eat buffet of creativity and sweat-equity. I hope you enjoy it.

Bon appetit!

## MAP NOTES:

While totally derivative of the Zeb map, my version is noticeably larger to allow for further exploration of uncharted space. I tried to include more information in subtle but attractive ways using a number of different mechanics. For example, Rim and Frontier planets are different colors; the class and color of each star can be estimated by just looking at them; and I made new system icons that I think are a little more distinct than the originals.

Additionally, I included two (optional) house-rule elements that others might find interesting:

1. "The Flow." The flow is an energy source that permeates the universe and interacts with traditional star-drive technology either as a boost or as resistance. It's an energy source that usually, but not always, emanates outward from large nebulae. The published distance of each charted star-route, equivalent to the number of light-years between systems (and consequently the typical number of days that traditional star-drive takes to make the journey) acts as the base. However, when moving with the flow travel is d10% faster. When moving against (what Rim privateers call, "Swimming up river"), its d10% slower.

This helps add a little more variability to long-distance space travel on the Frontier and introduces some significant tactical issues for large-scale defensive and offensive actions.

2. "Donal's Reach." The Donal's Reach system is essentially my fingerprint on the map. It is the naming of the furthest semi-explored point on the original Zeb design. Nestled within a hollow of the Xagyg Dust Nebula, very near to suspected Sathar space, it has become a hotbed of controversy after Captain Donal of the SS Gillette disappeared from the location during a spectacularly brief, and very public, broadcast of his initial moments out of star-drive. Sathar foul-play is suspected, though many conspiracy theories exist. One popular theory, with some credible evidence rising from an encrypted sub-space signal that was twisted into the public broadcast, suggests that some dubious mega-corp may have disrupted the transmission after intercepting the valuable star-route and system-resource data. Whatever the truth may be, Captain Donal and his crew have never been heard from again. Despite that, many people are busily trying to decrypt Captain Donal's last "hidden" broadcast while others are planning new expeditions.

(When Darrell isn't reminiscing about all the light years that have past, he's pretending to write and publish comics:

<http://www.brokenhalos.safwebshop.com> ★

**Editor's Note:** Darrell is also working on an excellent remake of the Serena Dawn deckplan – one that could be used in tabletop gaming or using the excellent virtual tabletop software whose link is shown in the ad at right. If he gets it done on time, you'll all see it in Issue #7!

Computer Gaming Tools for all your... Needs!

- ▶ Virtual Table-Top
- ▶ Token Creation
- ▶ Initiative Management
- ▶ & Digital Dice

RP TOOLS

<http://rptools.net/doku.php>

# BUYING AND SELLING

C. J. Williams

The frontier is wide open and is not governed by galaxy-wide standards. Different worlds trade in different ways. Some provide a set price, while others haggle. Some worlds leave it to individual territories or even each establishment to determine how trade is carried out. Many bazaars exist throughout the frontier. Often characters will get shaken down by a vendor if they're not careful. The art of haggling is thus very important.

Also of importance is item quality. Items aren't always perfect. There are many manufacturers with many products of varying degrees of quality and cost.

There are many other factors that can lead to the adjustment of cost. Introducing this type of commerce into your campaign can add a flavor of being in a struggling society out on a wide frontier.

## HAGGLING

Intelligence and a strong presence affect haggling skills greatly. Everyone has to barter at some point or other, so everyone is experienced with it, but not everyone haggles effectively.

To determine haggling score, add your character's INT and PER and then divide by 2. Modify the cost of the item in question by looking up the difference between your character's haggling score and the NPC's haggling score in the following table. If you prefer to roll for success, add the difference to your total if above the NPC, or subtract the difference from your total if below the NPC, and roll 1d100.

**HAGGLING TABLE**

Difference	Cost Modifier
1-5	--
6-10	+/- 5%
11-20	+/- 10%
21-30	+/- 15%
31-40	+/- 20%
41-50	+/- 25%
51-60	+/- 30%
61-70	+/- 35%
71-80	+/- 40%
81-90	+/- 45%
91-00	+/- 50%

You pay the cost of the item based on the difference between your score and the roll.

To simplify things further, you can simply take a list of items needing to be purchased and roll against your score to determine the cost of items purchased.

Your Referee may still require you to roleplay the sale after determining the difference through basic comparison of your score against the NPC's score. In such cases, you will want to make a good show of haggling or your Referee may choose to adjust the cost.

Note that new vehicles and engines cannot be haggled below 15% off unless they are used or are acquired through the underground market.



## TAXATION

It is said that there are only two things in life that are certain: death and taxes. In the seeming need to avoid the issue of taxes, most role-playing games, Star Frontiers being no exception, leave taxes out of the system entirely. This is certainly understandable, as this can complicate even the simplest games. I certainly wouldn't want to break this tradition in the Star Frontiers game. Let's just say that the taxes are in at least some of the prices we are paying and that the corporations pay other living taxes for their employees.

## QUALITY (VALUE)

All things made have varying levels of quality from very poor to extremely high, and this is demonstrated through design, workmanship, and quality of materials.

When a pre-owned item is purchased, roll on the following chart to determine its quality. If the quality is already known, and is to be purchased, multiply the list price by the percentage provided and add or subtract that number from the normal listed price.

**QUALITY TABLE**

Roll	Quality	Item Level*	Bonus/ Penalty
00-04	High Quality	6	+20%
05-19	Very Good	5	+10%
20-29	Good	4	+5%
30-39	Average	3	0
40-69	Poor	2	-5%
70-86	Very Poor	1	-10%
85-96	Disposable	0	-20%
97-99	Worthless	--	--

Experimental items move up this list with each stage, starting with Disposable.

To move an item up the list that was acquired from a junk dealer (See Junk Dealers below), a person with the appropriate repair skill can repair an item of equal or lower level by taking 1 day for each difference in level of the item minus 1 for each level of the repair skill used times the number of steps moved up in quality. You cannot move an item further up in quality than its original quality level.

Bonuses and penalties also apply to all rolls made with the item. Add the number to the percentage chance. Additionally, the percentage is added to or subtracted from 100 each time the item is used or when determining structural failure according to the damaged item rules in the Alpha Dawn Expanded Rulebook.

## AGING ITEMS

The age of an item will affect its quality. Every item moves down in quality 1 step for each PanGal year up to 3 years after its creation, and then 1 step for every .5 PanGal years. An item may be repaired, but still must follow age progression. If repaired after the first 3 PanGal years, the quality still continues to drop every .5 PanGal years.

*Example: An item repaired in its second year takes 2 steps down in quality over the next 2 years, and then a step for each .5 PanGal years afterward.*

To randomly determine the age of a salvagable found item, use the Age Table.

**AGE TABLE**

Roll	Age
98-00	New
93-97	.5 yrs
85-92	1 yr
78-85	1.5 yrs
70-78	2 yrs
61-69	2.5 yrs
51-60	3 yrs
41-50	3.5 yrs
32-40	4 yrs
24-31	4.5 yrs
16-23	5 yrs
11-15	5.5 yrs
01-10	6+ yrs

## QUANTITY (VOLUME)

The amount of supplies you purchase can decrease expenses for you.

**QUANTITY TABLE**

Item*	Qty	reduced**
Staples	20 lbs.	%5
Technology	20 ct.	%10
Chemicals	20 gal	%5
Fuels	100 gal or 100 ct	%5

\* Each product only. For instance, not just all fruit, but bananas only.

\*\* Add a zero to the Qty to reduce the cost even further by the stated percent.

Under special circumstances, such as seeking to get rid of stock, a merchant may reduce his costs to be lower than the cost reductions in the table above.

## AVAILABILITY

Different products are more readily available in some places than in others. The price of an item may be adjusted by the Referee based on its availability to the region, legality, rarity, or special order. This is the Referee's

**AVAILABILITY TABLE**

Circumstance	General Adjustment
Imported	Up to +20%
Contraband	Up to +50%
Questionable Acquisition	-50%
Rare	Up to +30%
Special Order	At cost
Direct	Up to -30%

discretion based on the region and item.

**Region.** The region can affect the product's availability through distance and legality. A region may be a whole section of space, a solar system, or just a single planet.

**Legality.** When an item can be obtained, but is illegal for public consumption, this can affect the cost substantially. If legally obtained from another source and in good demand, but illegal for general sale, known as contraband, the item may be marked up considerably and haggling is usually almost non-existent. If acquired through some question of legality, such as stolen, it is in need of being moved quickly, so the item may already be reduced in cost and may be easily haggled down further.

**Rarity.** Some items are exceptionally rare no matter where you buy them. These items are usually in very high demand, driving their cost up substantially. If you're after a rare item, expect to pay a hefty sum.

**Special Order.** These are items that the merchant doesn't normally sell or they are currently out of stock on. You are generally only allowed to pay the full cost of the item without haggling. If the item was on sale, you may order it at the sale price only if you pay in advance.

**Direct.** Sometimes you can purchase items directly from the manufacturer if you buy on the planet of the manufacturer. This can afford you some significant cost reductions up to 30% off the listed price for new items.

## SERVICES

Common services such as engine repairs, overhauling, weapon repairs are all subject to differences in cost in similar ways to products so may use many of the same tables from this article, but are usually not able to be haggled, unless dealing with individual contract workers.

## UNDERGROUND MARKET

The closer you get to the rim worlds and further away from Pan-Gal, the more expensive items and fuel are. This is because of both traveling distances and piracy. Because of this, the most expedient and least expensive purchases are going to be those found on the black market.

## SMUGGLING

Smuggling is a lucrative business in the frontier. With so many trying to avoid detection or the transfer of questionable or much needed materials for starving colonies, smuggling is the cogs that keep the Frontier moving. For this reason, it is tentatively tolerated by the authorities.

Smuggling is a great way to make money and is also a great way to acquire anything you need. For the right price, a smuggler is often willing to transport any goods you ask them to.

Generally, the cost for smuggling items will be around 1/3 the actual cost of the items. Use the haggling chart above to adjust the cost

## SLAVERY

Slavery is a condemned practice in the UPF, but may be found on certain rim worlds, especially among certain rim races. Star Law does not enforce anti-slavery laws on the rim worlds unless the physical health of the slaves are being endangered, and when certain people of at least moderate importance are forced into slavery.

Slavery is also looked down upon because of the availability of robots. If you wish to buy a slave for whatever reason, it will cost you around 20,000 Cr. The tables in this article may also apply to slave purchases. There are 3 types of slaves: those who are force into slavery, those who are paying off a debt, and those who volunteer themselves to slavery in exchange for food and lodging. Those forced into slavery are considered to be under Questionable Acquisition in the Availability Table.

## JUNK DEALERS

Salvage is a booming business, making junk dealers extremely common and a good alternative to the underground market or paying the full price for new items. However, without someone to repair or reconstruct the item, there are going to be quality issues affecting the item. Roll twice on the Quality Table. Whichever roll is higher is the unchangeable original market condition of the item. The lower roll is the current condition of the item.

## LOCAL BARGAINING CUSTOMS

Different worlds and different species have varying customs for trade. It's important that your character be familiar with the local customs or he/she could inadvertently end up offending someone and even getting him or her self run out of town if not shot.

## CORE WORLDS

Customs on the core worlds are fairly amalgamated, but there are still certain differences that are good to know.

**Dramune.** Cut to the chase. Dramune is a world with a dark past and secretive tendencies. They don't like to pussyfoot around. They want to know why you're there and what your offer is.

**Pan-Gal.** Small talk before the sale. In contrast to Dramune, Pan-Gal is the heart of the UPF and Star Law. Everything is either by the book, or needs careful

discussion to get hints for, so it is just a matter of course that every merchant is going to talk you to death, even if only to live through the excitement of the stories you have to tell. So be patient and guide the conversation toward the end of the sale. It won't offend them. They're used to it.

**Zebulon.** Act like each and every offer of the other person is outrageous. The seller glorifies its good points while the buyer deflects with equally exaggerated bad points to express why a certain cost should be retained or lowered.

## OUTER REACHES

The worlds of the more isolated outer reaches are more diverse and dangerous. The more your character knows about the local customs, the safer your character will be.

**Capella.** Continually shake hands during negotiation. Start with offering outrageous sum for the item, then seller obligatorily rejects the sum as too much, then the seller gives a more realistic sum that you may now haggle on.

**Hades.** Handshake under cloth using fingers to negotiate cost while conducting small talk. -10 haggling modifier to characters not from Hades. Attempts to negotiate any other way, or breaking off the negotiations can lead to deadly conflicts.

**Hents.** Obligatory gift exchange and constant blessings between offers. Yazirians are a religious and oft times superstitious lot, so blessings help put them at ease. In fact, it is considered an insult if you don't offer a blessing upon meeting with any Yazirian on a Yazirian world. Strangers and outsiders are not trusted to begin with, but not providing blessings can make one an absolute outcast.

**K'tsa Kar.** Squat (or sit in a chair) and show disinterest (minimal eye contact). Vrusk are very intelligent and find haggling to be very mundane, so their haggling practices are going to reflect their attitude toward it.

**Theseus.** Unbroken eye contact while performing the negotiation forming each offer as a demand (You may blink). Theseans want to be trusting, but they've received many bad deals in the rim, so they want to look you in the eye and know if you're telling the truth or not. Theseans receive +5 to perception checks to detect deception during transactions.

## ACQUIRE NEW ADVENTURES

Buying and selling can lead to adventure in many ways, including sales gone bad to accidentally acquiring a private project that got tossed out and now a crime lord is after it. Whatever the case, adventure is one sale away.





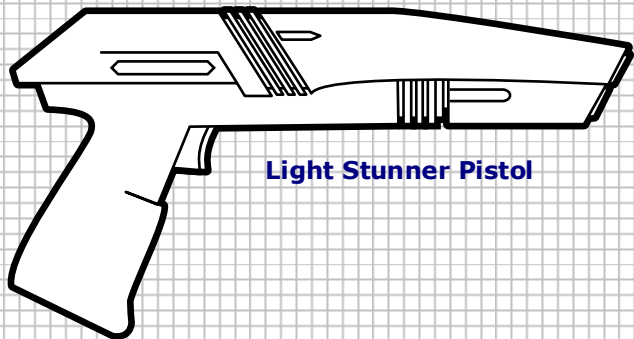

Light Stunner Pistol

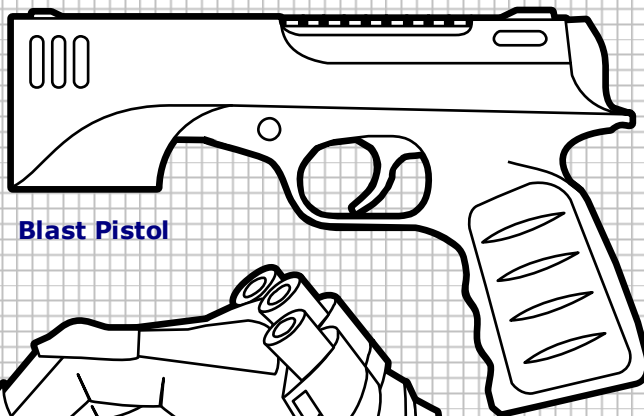

Blast Pistol

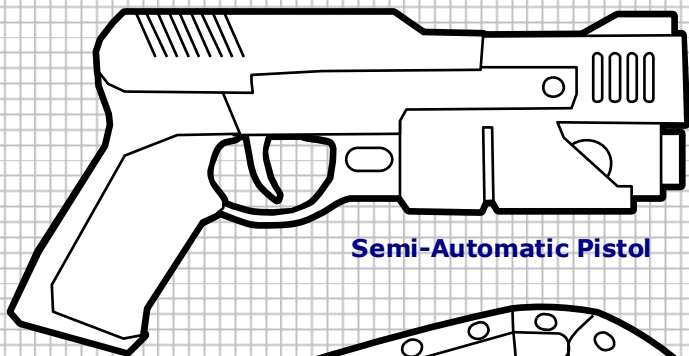

Semi-Automatic Pistol

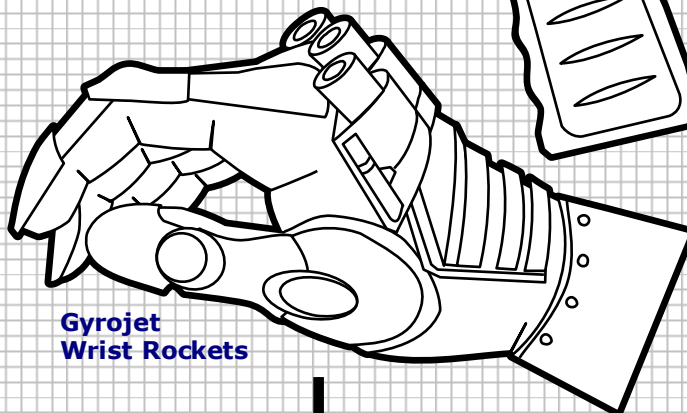

Gyrojet Wrist Rockets

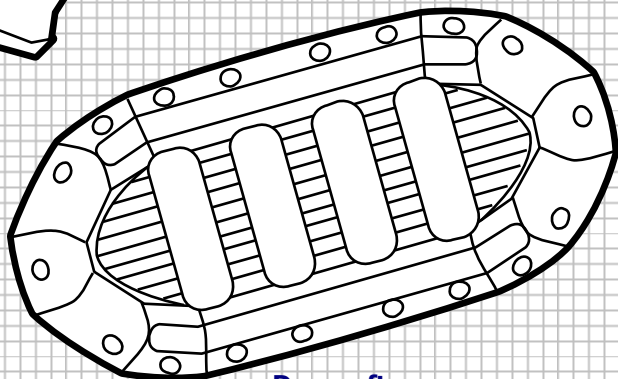

Duraraft

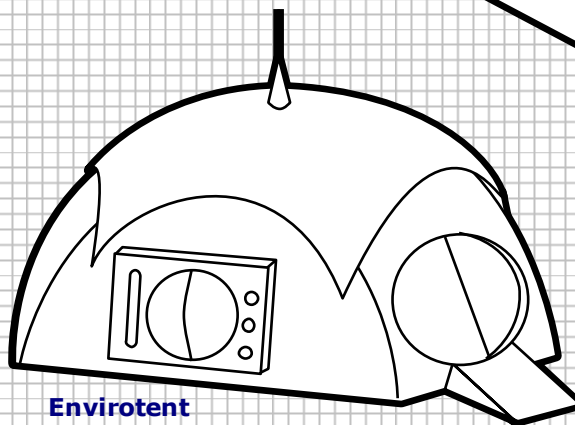

Envirotent

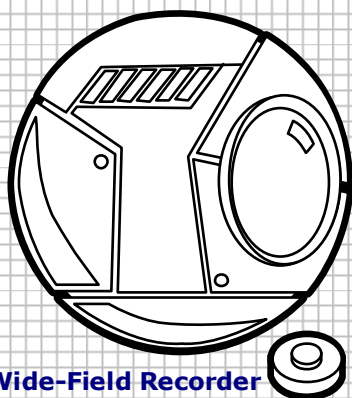

Wide-Field Recorder

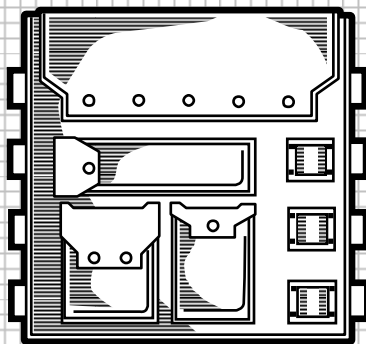

Survival Kit

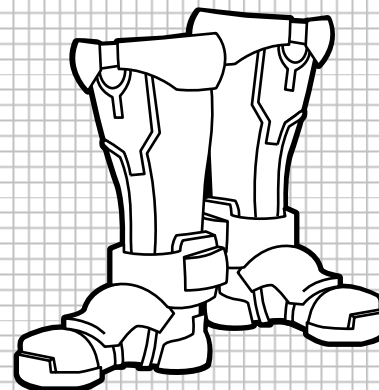

Jumpboots

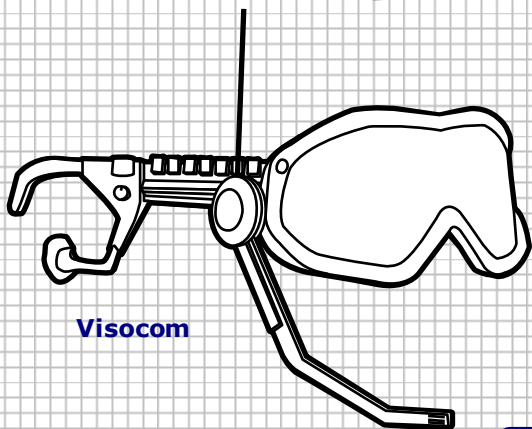

Visocom

When I put out the first issue of the StarFrontiersman, I didn't know it would be enjoyed by so many people. I also didn't know I could draw gear. I stole the art I used in that first issue by perusing the 'net. I didn't give proper credit to the artists - and frankly have no idea where I found the art I used. I now get proper permission to use images and art. I've also developed techniques to create the artwork myself, and have found talented artists who enjoy helping our cause. So here are all the equipment illustrations from Issue #1 redrawn or re-realized with original imagery. Some are derivatives of the originals, some of are completely new and unique. All are free for you to enjoy, use or discard. I'll update the PDF of Issue #1 with these images a few days after release of this issue.

Game on!

-Bill Logan

# CLASSIFIEDS

## SAFE ADVENTURE AWAITS!

Grand Opening!

Ultima Islands, located on the PGC planet Exodus. Ten long years in the making, this is bound to be the greatest tourist attraction in the Frontier!

- Over 1,000 cybot actors.
- Safe simguns and simswords, used to simulate dangerous adventure.
- Join us on gladiator island, pirate island, fantasy island, old west island, and more!
- Ongoing plotlines, so get your season passes and return often.
- Reduced starliner rates with complete hotel package purchase.

1 weekend only 350 Credits, while introductory rates last.

Chronocom Subspace Relay#  
**73748594837262090012**

## USED INERTIA DAMPENER

Only used once, complete with Type II Parabattery. Complete with original runnel-rods and taral filters. 2,500Cr or best offer.

Chronocom Subspace Relay#  
**11199299101161827261**

## WORK FROM HOME

Make thousands of credits each month, working part time from your own home!

Eversafe Enterprises is looking for work-at-home assemblers of a new product line. Interested parties should contact Maraa or Sh'ssta at the number listed below.

Special non-disclosure agreement is mandatory. Competitors please do not apply.

Chronocom Subspace Relay#  
**67675654342343545324**

## WHY DIE WHEN IMMORTALITY IS YOURS FOR THE TAKING?

Iceworks Enterprises, a subsidiary of Medicorp, would like to offer you a chance at immortality. Through modern cryogenetic technology, your body can be frozen now and thawed out at a time of your choosing. Come back in a century, or when something specific comes to pass. Outlive your enemies, your debts, and your mistakes. A fresh start at a time of your liking.

*All interviews are discrete.*

Chronocom Subspace Relay#  
**10029030400020200502**

## I'M TIRED OF WAITING

Wanted: Tordia Trell  
Description: Short thin female human, red hair green eyes, pasty skin.  
Reward: 15,000 Credits for her capture. I don't want her harmed.  
Reason: Grand Debt, Theft of Personal Property

Contact Groko Ahmstadt at:

Chronocom Subspace Relay#  
**99388222220120201222**

## EXPLORERS WANTED

Streel Corporation is mounting an expedition to the asteroids of Gruna-Garu. Seeking mineral rights. Last ship didn't return - bonus pay for an explanation of the whereabouts of the *SST Kurioso*.

Interested participants must have own ship and must not mind avoiding Gruna-Garu authorities, as the details of the mineral rights agreement are not yet finalized.

Chronocom Subspace Relay#  
**18888777998754332323**

## KAKATAK'S USED VEHICLES

Our selection of heavy duty explorers cannot be equaled. Will match any legitimate price of same model from any other dealer. Most only used a few times. Some equipped with weapon bays (weapons not included). Will modify or paint to custom specifications (no smuggling bays, please).

Located 11km south of Vorah's Wells in the northern deserts of Zik-kit (Kizk'-Kar).

Chronocom Subspace Relay#  
**65678654368646447789**

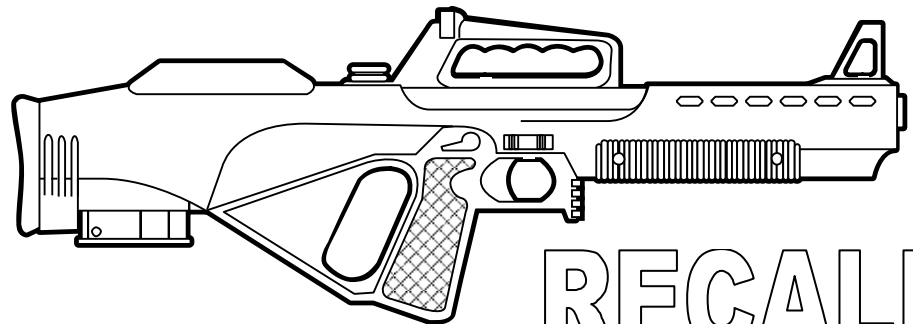

## WARTECH MGH-1

A design flaw in the recently-released Wartech MGH-1 infantry rifle is immediate and mandatory! The weapon's power source has a tendency to bleed back into the firing coils, causing the entire magazine of bullets to explode. Do not use!! Return to your place of purchase or contact us immediately. We apologize for any deaths or dismemberments:

Chronocom Subspace Relay#  
**77773377778902736626**

# RECALL!